

**fit interiors**

**Atelier**



# Atelier

Italiano	3
English	8
Deutsch	13
Français	18
Español	23

# Atelier

## Dimensioni

- Singola colonna: L 450 mm / P 550 mm / H 2100 mm
- Altezza totale con lo zoccolo: 2170 mm

## Caratteristiche generali

- Armadio realizzato con pannelli in MFC spessore 18 mm bordati in ABS con colla poliuretanic
- Due griglie di ventilazione per vano
- Barra appendiabiti o gancio per vano
- Piedini regolabili
- Cerniere certificate per 80.000 cicli di apertura e chiusura
- Serratura a chiave (con 2 chiavi + braccialetto portachiave numerato) o lucchettabile

## Caratteristiche specifiche

- Armadietti a colonna singola
- Anta in MFC in varie finiture legno (vedi The Swatch Book)
- Struttura interna in due colori legno: antracite o cashmere
- Cerniere ammortizzate
- Angolo di apertura dell'anta 170°
- Due grucce appendiabito per vano
- Numero per anta in adesivo resinato con logo Fit Interiors

## Opzionale disponibile su richiesta

- Altre tipologie di serratura (meccanica o elettronica)
- Maniglie a scelta tra tutte le tipologie
- Altre tipologie di numero
- Zoccolo in tre colori: argento, nero, bianco
- Portadocumenti
- Specchio
- Cestello portaoggetti
- Presa USB
- Top o top con LED
- Pannelli laterali terminali o pannelli laterali terminali con LED
- Gruccia antifurto in legno

### ANTA

LEGNO + FINITURE



### CASSA

LEGNO + FINITURE



ANTRACITE



CACHEMIRE





**ANB01-19**  
Armadio 1 ante

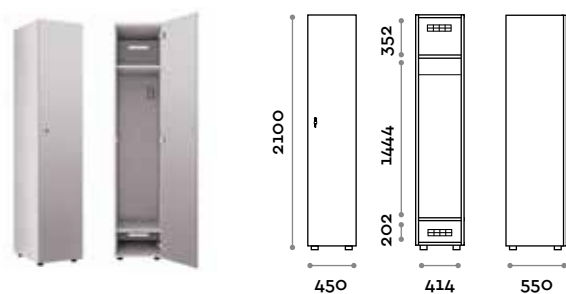

**ANB11-19**  
Armadio 1 ante per panca

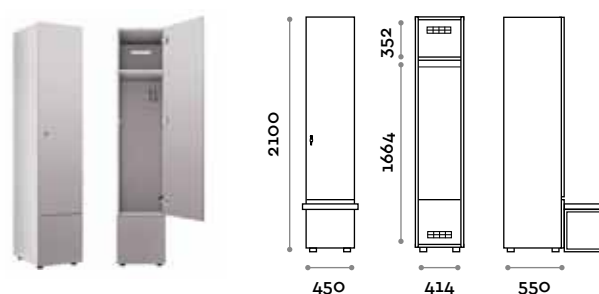

**ANB02-19**  
Armadio 2 ante

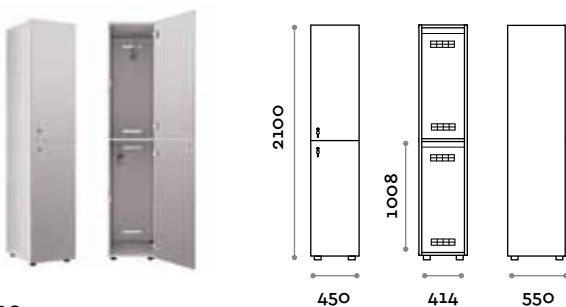

**ANB12-19**  
Armadio 2 ante per panca

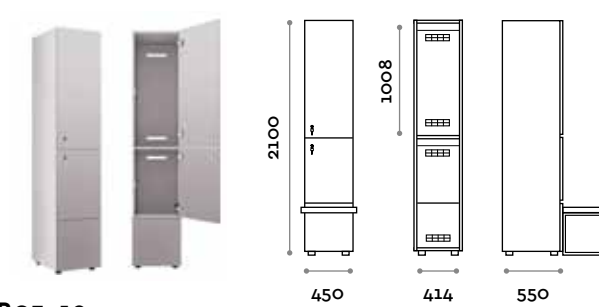

**ANB03-19**  
Armadio 2 ante a "L"

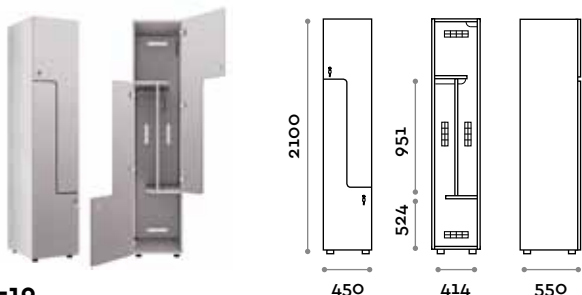

**ANB05-19**  
Armadio 5 ante

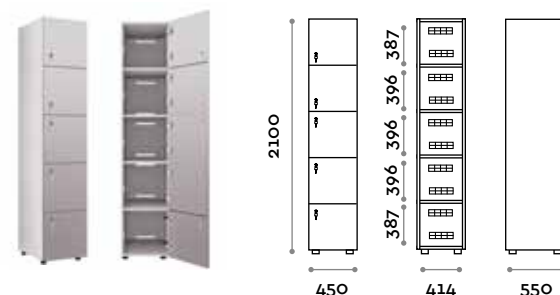

**ATRO2-19**  
Armadio 2 ante trapezoidali

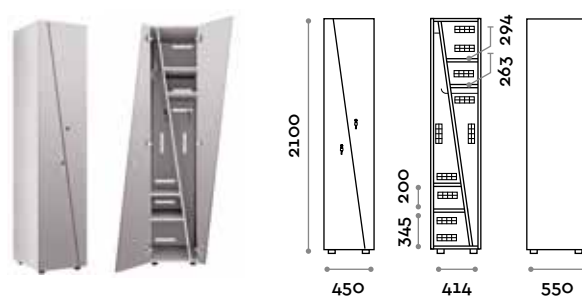

## Maniglie

**HAN 01**  
Maniglia in zama

Dimensioni  
L 10 mm / P 30 mm / H 106 mm



cromo lucido

cromo opaco

**HAN 02**  
Pomolo in zama

Dimensioni  
Ø 20 mm / P 25 mm

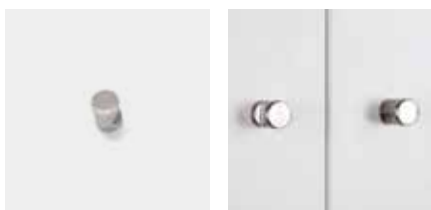

cromo lucido

**HAN 03**  
Maniglia ad incasso in zama

Dimensioni  
L 42 mm / P 12 mm / H 106 mm

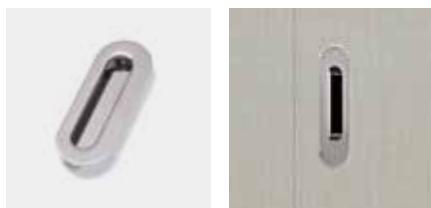

cromo lucido

**HAN 04**  
Maniglia in zama

Dimensioni  
L 50 mm / P 25,7 mm / H 80 mm



titanio

**HAN 05**  
Maniglia in zama

Dimensioni  
L 22 mm / P 18 mm / H 158 mm



cromo lucido

bianco

antracite

**HAN 06**  
Maniglia in alluminio

Dimensioni  
L 16 mm / P 36 mm / H 198 mm



anodizzato lucido

**HAN 07**  
Maniglia in zama

Dimensioni  
L 69 mm / P 26 mm / H 69 mm



cromo lucido

**HAN 08**  
Pomolo in plastica

Dimensioni  
Ø 35 mm / P 28 mm

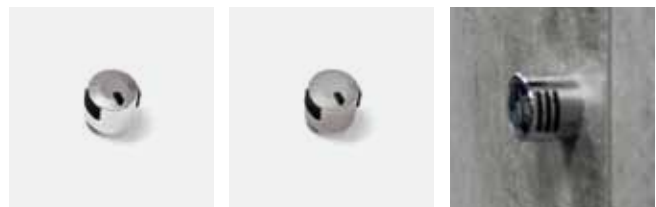

argento lucido

argento opaco

## Serrature

Serrature a chiave o lucchettabile incluse



Lucchettabile



Chiave

Opzionali su richiesta



**ACCMON**  
Serratura moneta

Serratura digitale con batteria



**ACCXVER**  
Axis vertical



**ACCDLKN**  
Next CUE



**ACCXSTD**  
Axis standard



**ACCDKSO**  
Solag

Serratura di prossimità



**ACCXSTDRFID**  
Axis standard



**ACCAXVERRFID**  
Axis verticale



**ACCDLKNRFID**  
next cue



**ACCOJPRO**  
Ojmar



**ACCGAT**  
mod. 7010

Serratura a combinazione meccanica

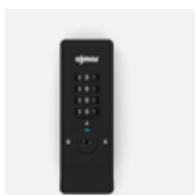

**ACCCOMBI**  
Combi Lock



**ACCDKDI**  
Digilock DIAL



**ACCKEYLESS**  
P1

## Accessori

### Inclusi



**ACCAPP**  
Gruccia in plastica

### Opzionali su richiesta



**ACCDOC**  
Portadocumenti



**ACCSPM**  
Specchio

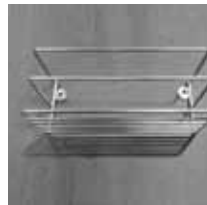

**ACCES**  
Cestello



**ACCUSB**  
Presa USB



**ACCTOP**  
Top



**ACCTAM**  
Pannelli laterali



**ACCGRU**  
Gruccia antifurto in legno



Numero adesivo  
resinato con logo  
Fit Interiors



Numero perforato  
su piastra in acciaio



Numero inciso su  
piastra in acciaio



Numero ritagliato su  
piastra in acciaio



Zoccolo argento



Zoccolo bianco



Zoccolo nero

# Atelier

## Dimensions

- Single column: W 450 mm / D 550 mm / H 2100 mm
- Height with skirting board: 2170 mm

## General characteristics

- Locker made of MFC panels thickness 18 mm edged in ABS with poliurethanic glue
- Two ventilation grids for each compartment
- Bar for coat hangers or hook for each compartment
- Adjustable feet
- Hinges certified for 80.000 opening cycles
- Keylocks (with 2 keys + numbered locker key wrist strap) or a padlock system

## Specific characteristics

- Lockers single column
- Door in MFC panel in various wood finishes (see The Swatch Book)
- Internal structure in two wood colors: anthracite or cashmere
- Braked hinges
- Door 170° opening angle
- Two coat hangers for compartment
- Handles to choose from all types
- Number made of PVC with Fit Interiors logo

## Optional available on request

- Other types of lock (mechanical or electronic)
- Handles to choose from all types
- Other types of number
- Skirting board in three colors: silver, black, white
- Document holder
- Mirror
- Storage basket
- USB socket
- Top or top with LED
- End side panels or end side panels with LED
- Anti-theft wooden hanger

### DOOR

#### WOOD + FINISHES



### FRAME

#### WOOD + FINISHES



ANTHRACITE



CASHMERE







**ANB01-19**  
Single column 1-tier locker

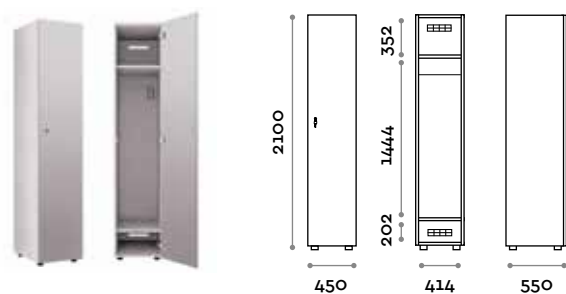

**ANB11-19**  
Single column 1-tier locker – bench version

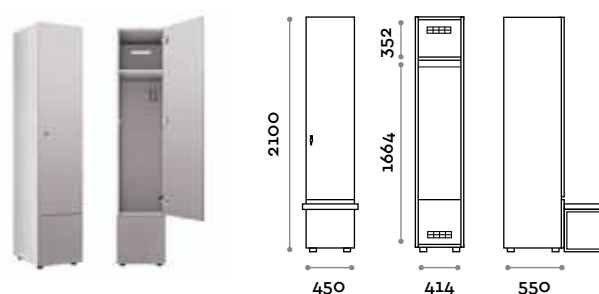

**ANB02-19**  
Single column 2-tiers locker

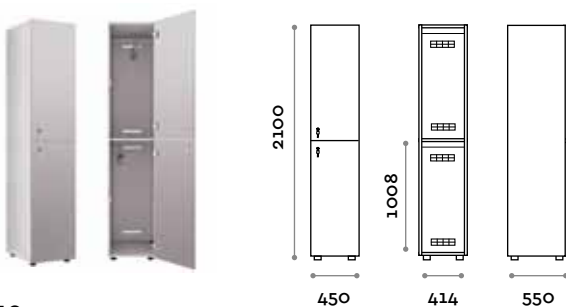

**ANB12-19**  
Single column 2-tiers locker-bench version

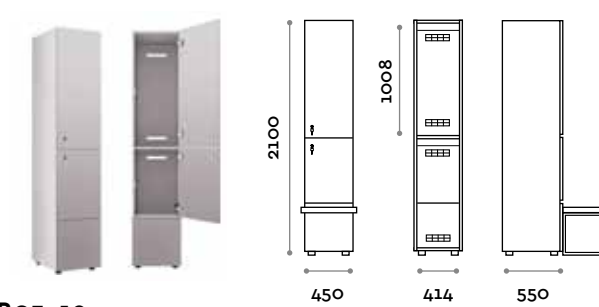

**ANB03-19**  
Single column locker with 2 L-shaped doors

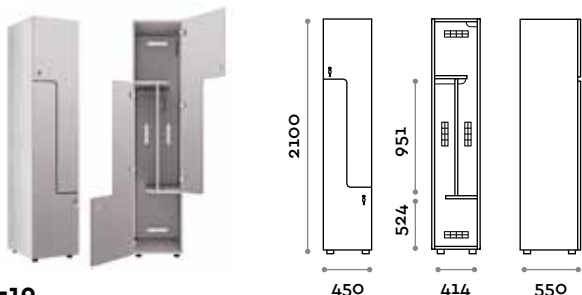

**ANB05-19**  
Single column 5-tiers locker

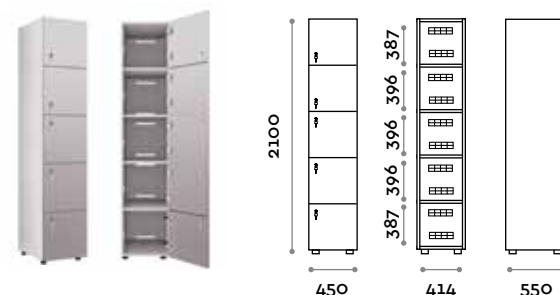

**ATRO2-19**  
Single column locker with 2 trapezoidal doors

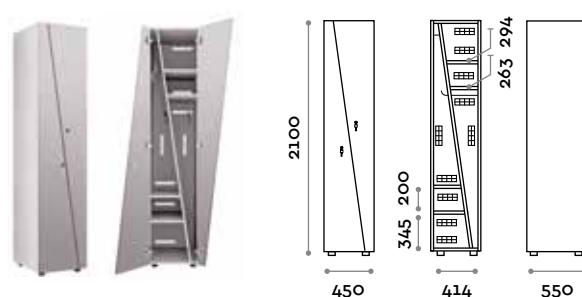

## Handles

### HAN 01 Zamak handle

Dimensions  
W 10 mm / D 30 mm / H 106 mm



polished chrome      matt chrome

### HAN 02 Zamak knob

Dimensions  
Ø 20 mm / D 25 mm

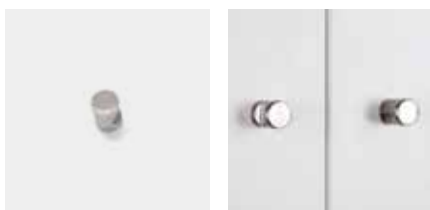

polished chrome

### HAN 03 Zamak handle

Dimensions  
W 42 mm / D 12 mm / H 106 mm



polished chrome

### HAN 04 Zamak handle

Dimensions  
W 50 mm / D 25,7 mm / H 80 mm



titanium

### HAN 05 Zamak handle

Dimensions  
W 22 mm / D 18 mm / H 158 mm



polished chrome      white      anthracite

### HAN 06 Aluminium handle

Dimensions  
W 16 mm / D 36 mm / H 198 mm



polished anodised

### HAN 07 Zamak handle

Dimensions  
W 69 mm / D 26 mm / H 69 mm



polished chrome

### HAN 08 Plastic knob

Dimensions  
Ø 35 mm / D 28 mm



polished silver      matt silver

## Locks

Keylock or padlock included



Padlock



Keylock

Optional on request



**ACCMON**  
Coin lock

Digital lock with battery



**ACCXVER**  
Axis vertical



**ACCDLKN**  
Next CUE



**ACCXSTD**  
Axis standard



**ACCDKSO**  
Solag

Proximity lock



**ACCXSTDRFID**  
Axis standard



**ACCAXVERRFID**  
Axis vertical



**ACCDLKNRFID**  
next cue



**ACCOJPRO**  
Ojmar



**ACCGAT**  
mod. 7010

Mechanical combination lock

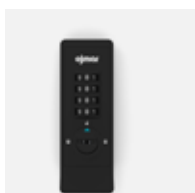

**ACCComBI**  
Combi Lock



**ACCDKDI**  
Digilock DIAL



**ACCKEYLESS**  
P1

## Accessories

### Included



**ACCAPP**  
Plastic hanger

### Optional on request



**ACCDOC**  
Document holder



**ACCSPM**  
Mirror



**ACCES**  
Storage basket



**ACCUSB**  
USB socket



**ACCTOP**  
Top



**ACCTAM**  
End side panels



**ACCGRU**  
Anti-theft wooden hanger



Number in PVC with  
Fit Interiors logo



Perforated number  
on a stainless steel  
plate



Number engraved  
on a stainless steel  
plate



Number cut on a  
stainless steel plate



Skirting board silver



Skirting board white



Skirting board black

# Atelier

## Abmessungen

- Einzelschrank: B 450 mm / T 550 mm / H 2100 mm
- Gesamthöhe mit Sockel: 2170 mm

## Allgemeine Eigenschaften

- Schrank, gefertigt mit Platten aus 18 mm starkem MFC und mit Polyurethan-Leim geklebten Einfassungen aus ABS
- Zwei Lüftungsgitter pro Fach
- Kleiderbügelstange oder Kleiderhaken im Fach
- Verstellbare FüÙe
- Für 80.000 Öffnungs- und Schließzyklen zertifizierte Scharniere
- Schlüsselschloss (mit 2 Schlüsseln + nummeriertes Schlüssel-Armband) oder Vorhängeschlosssystem

## Spezifische Eigenschaften

- Einzelschränke
- Tür aus MFC in verschiedenen Holz Ausführungen (siehe The Swatch Book)
- Innenstruktur in zwei Holzfarben erhältlich: Anthrazit oder Cashmere
- Gedämpfte Scharniere
- Öffnungswinkel der Tür 170°
- Zwei Kleiderbügel pro Fach
- Nummer für Tür aus selbstklebendem Resinat mit Emblem Fit Interiors

## Optional auf Anfrage erhältlich

- Andere Schlosstypen (mechanisch oder elektronisch)
- Griffe nach Wahl unter allen verfügbaren Typen
- Andere Nummertypen
- Sockel in drei Farben: Silber, Schwarz, Weiß
- Dokumentenfach
- Spiegel
- Ablagekorb
- USB-Anschluss
- Top oder Top mit LED
- Abschließende seitliche Platten oder abschließende seitliche Platten mit LED
- Hotel-Kleiderbügel aus Holz



## TÜR

HOLZ + AUSFÜHRUNGEN



## GEHÄUSE

HOLZ + AUSFÜHRUNGEN



ANTHRAZIT



CACHEMIRE





**ANBo1-19**  
Schränk mit 1 Tür

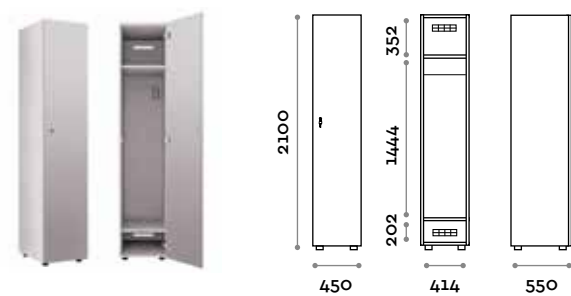

**ANB11-19**  
Schränk mit 1 Tür für Bank

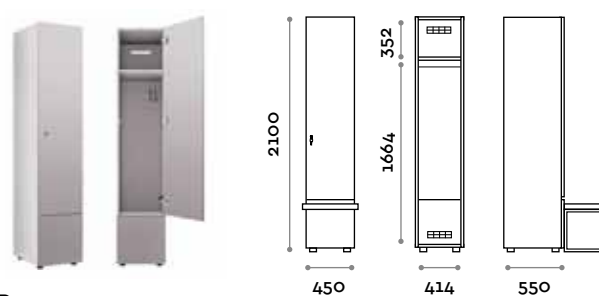

**ANBo2-19**  
Schränk mit 2 Türen

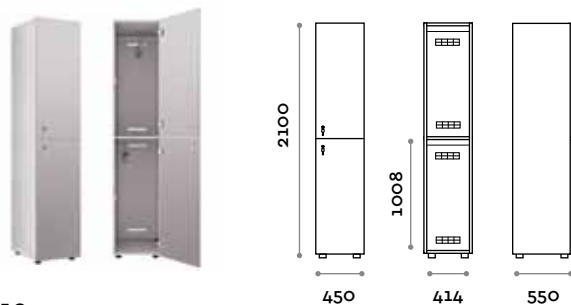

**ANB12-19**  
Schränk mit 2 Türen für Bank

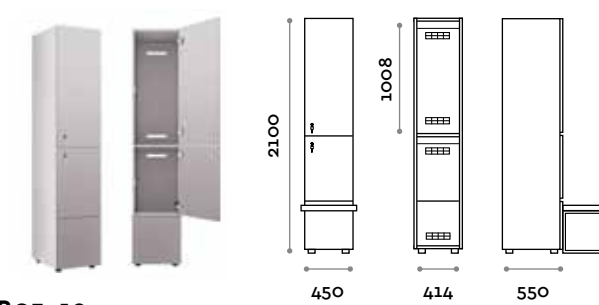

**ANBo3-19**  
Schränk mit 2 „L“-förmigen Türen

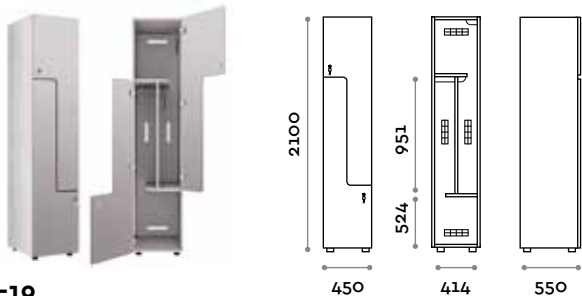

**ANBo5-19**  
Schränk mit 5 Türen

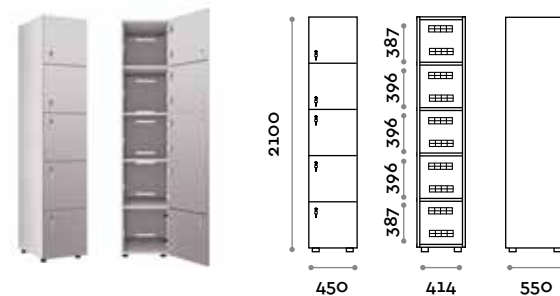

**ATRo2-19**  
Schränk mit 2 trapezförmigen Türen

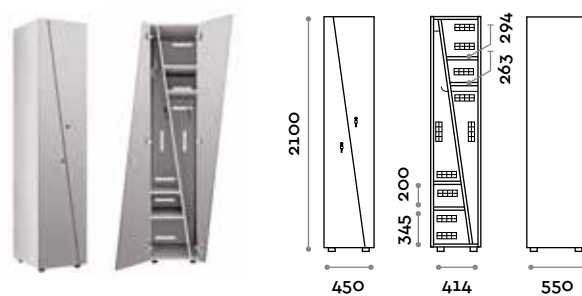

## Griffe

### HAN 01

Griff aus Zamak

Abmessungen

B 10 mm / T 30 mm / H 106 mm



Chrom glänzend

Chrom matt

### HAN 02

Knaufgriff aus Zamak

Abmessungen

Ø 20 mm / T 25 mm

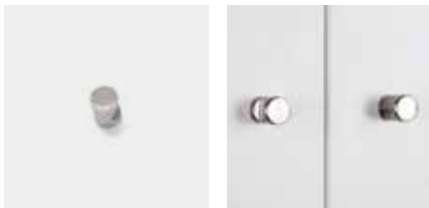

Chrom glänzend

### HAN 03

Griff aus Zamak

Abmessungen

B 42 mm / T 12 mm / H 106 mm



Chrom glänzend

### HAN 04

Griff aus Zamak

Abmessungen

B 50 mm / T 25,7 mm / H 80 mm



Titan

### HAN 05

Griff aus Zamak

Abmessungen

B 22 mm / T 18 mm / H 158 mm



chrom glänzend

Weiß

Anthrazit

### HAN 06

Griff aus Aluminium

Abmessungen

B 16 mm / T 36 mm / H 198 mm



eloxiert glänzend

### HAN 07

Griff aus Zamak

Abmessungen

B 69 mm / T 26 mm / H 69 mm



Chrom glänzend

### HAN 08

Knaufgriff aus Plastik

Abmessungen

Ø 35 mm / T 28 mm



Silber glänzend

Silber matt

## Schlösser

### Inbegriffen



Vorhängeschlosssystem



Schüssel

### Optional auf Anfrage



**ACCMON**  
Münzschloss

### Digitalschloss mit Batterie



**ACCXVER**  
Axis vertical



**ACCDLKN**  
Next CUE



**ACCXSTD**  
Axis standard



**ACCDKSO**  
Solag

### Näherungssperre



**ACCXSTDRFID**  
Axis standard



**ACCAXVERRFID**  
Axis vertical



**ACCDLKNRFID**  
next cue



**ACCOJPRO**  
Ojmar



**ACCGAT**  
mod. 7010

### Mechanisches Zahlenschloss



**ACCCOMBI**  
Combi Lock



**ACCDKDI**  
Digilock DIAL



**ACCKEYLESS**  
P1



## Zubehör

### Inbegriffen



**ACCAPP**  
Kleiderbügel aus Plastik

### Optional auf Anfrage



**ACCDOC**  
Dokumentenfach



**ACCSP**  
Spiegel

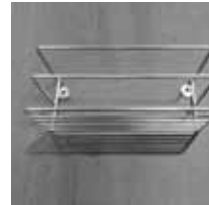

**ACCES**  
Korb



**ACCUSB**  
USB-Anschluss



**ACCTOP**  
Top



**ACCTAM**  
Seitliche Platten



**ACCGRU**  
Hotel-Kleiderbügel aus Holz



Klebstoffnummer  
mit Emblem von Fit  
Interiors



Schild aus Metall  
mit perforierter  
Nummer



Profiliertes Schild  
aus Edelstahl  
mit eingravierter  
Nummer



Nummer aus  
Stahlblech  
ausgeschnitten



Sockel Silber



Sockel Weiß



Sockel Schwarz

# Atelier

## Dimensions

- Colonne simple: L 450 mm / P 550 mm / H 2100 mm
- Hauteur totale avec la plinthe: 2170 mm

## Caractéristiques générales

- Casier réalisé avec panneaux en mélaminé, 18 mm d'épaisseur et chants en ABS avec colle polyuréthane
- Deux grilles de ventilation par compartiment
- Tringle ou crochet pour compartiment
- Pieds réglables
- Charnières certifiées pour 80.000 cycles d'ouverture et de fermeture
- Serrure à clé (avec 2 clés + bracelet porte-clés numéroté) ou cadénassable

## Caractéristiques spécifiques

- Casiers à colonne simple
- Porte en mélaminé en différentes finitions de bois (voir The Swatch Book)
- Structure intérieure en deux couleurs de bois: anthracite ou cachemire
- Charnières amorties
- Angle d'ouverture de la porte 170°
- Deux cintres par compartiment
- Numéro pour porte en adhésif résine avec logo Fit Interiors

## En option disponible sur demande

- Autres types de serrure (mécanique ou électronique)
- Poignées au choix parmi tous les types de poignées
- Autres types de numéros
- Plinthe en trois couleurs: argent, noir, blanc
- Porte-documents
- Miroir
- Porte-objets
- Prise USB
- Dessus ou dessus avec LED
- Panneaux latéraux d'extrémité ou panneaux latéraux d'extrémité avec LED
- Cintre en bois antiviol



## PORTE

### BOIS + FINITIONS



## CAISSE

### BOIS + FINITIONS



ANTHRACITE



CACHEMIRE





**ANBo1-19**

Casier 1 porte

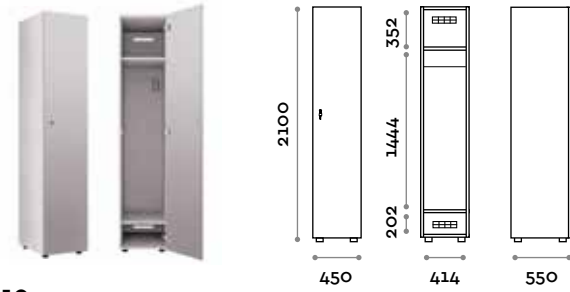

**ANB11-19**

Casier 1 porte pour banquette

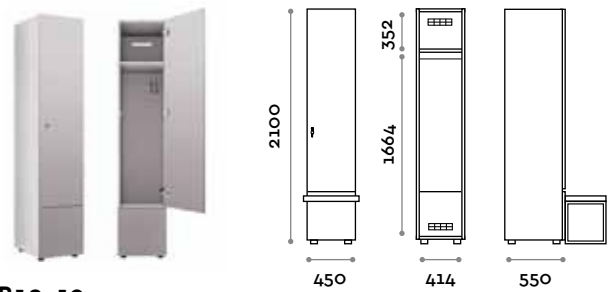

**ANBo2-19**

Casier 2 portes

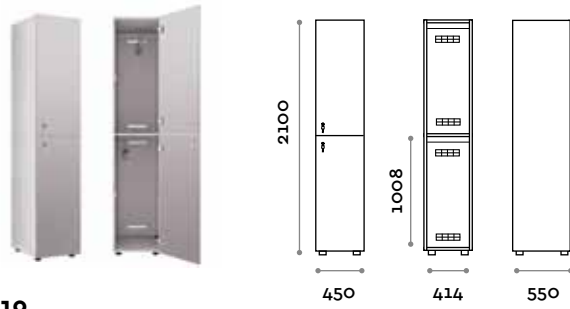

**ANB12-19**

Casier 2 portes pour banquette

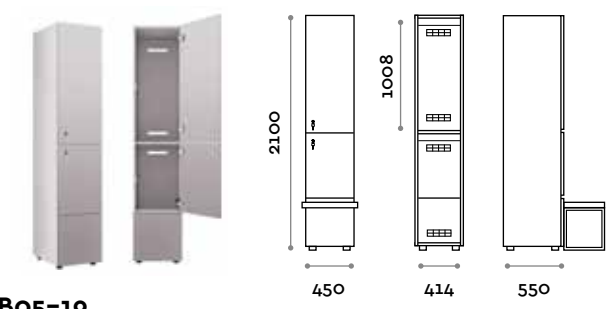

**ANBo3-19**

Casier 2 portes en L

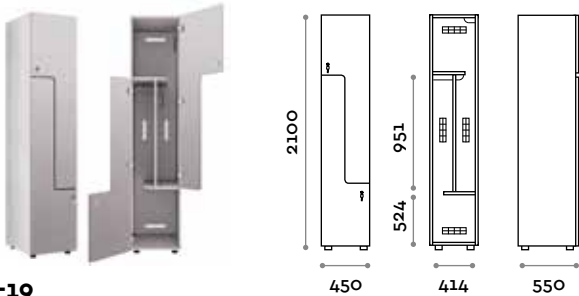

**ANBo5-19**

Casier 5 portes

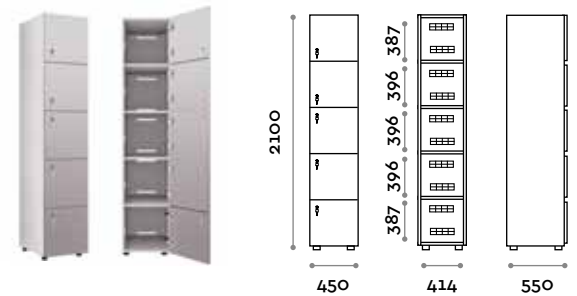

**ATRo2-19**

Casier 2 portes trapézoïdales

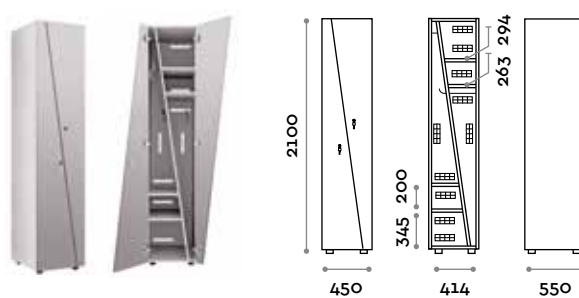

## Poignées

### HAN 01

Poignée en zamak

Dimensions

L 10 mm / P 30 mm / H 106 mm



chrome brillant



chrome mat

### HAN 02

Bouton en zamak

Dimensions

Ø 20 mm / P 25 mm



chrome brillant



### HAN 03

Poignée en zamak

Dimensions

L 42 mm / P 12 mm / H 106 mm



chrome brillant



### HAN 04

Poignée en zamak

Dimensions

L 50 mm / P 25,7 mm / H 80 mm



titane



### HAN 05

Poignée en zamak

Dimensions

L 22 mm / P 18 mm / H 158 mm



chrome brillant



blanc



anthracite

### HAN 06

Poignée en aluminium

Dimensions

L 16 mm / P 36 mm / H 198 mm



anodisé brillant



### HAN 07

Poignée en zamak

Dimensions

L 69 mm / P 26 mm / H 69 mm



chrome brillant



### HAN 08

Bouton en plastique

Dimensions

Ø 35 mm / P 28 mm

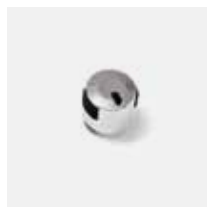

argent brillant

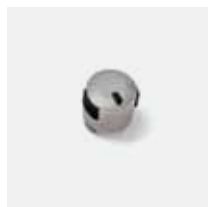

argent mat



## Serrures

### Incluses



Cadenassable



Clé

### Options sur demande



#### ACCMON

Serrure à monnaie

### Serrure numérique avec batterie



**ACCAXVER**  
Axis vertical



**ACCDLKN**  
Next CUE



**ACCAXSTD**  
Axis standard



**ACCDKSO**  
Solag

### Serrure de proximité



**ACCAXSTDRFID**  
Axis standard



**ACCAXVERRFID**  
Axis vertical



**ACCDLKNRFID**  
next cue



**ACCOJPRO**  
Ojmar



**ACCGAT**  
mod. 7010

### Serrure à combinaison mécanique



**ACCCOMBI**  
Combi Lock



**ACCDKDI**  
Digilock DIAL



**ACCKEYLESS**  
P1

## Accessoires

### Inclus



**ACCAPP**  
Cintre en plastique

### Options sur demande



**ACCDOP**  
Porte-documents



**ACCSPM**  
Miroir

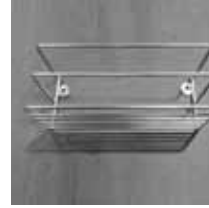

**ACCES**  
Porte-objets



**ACCUSB**  
Prise USB



**ACCTOP**  
Dessus



**ACCTAM**  
Panneaux latéraux



**ACCGRU**  
Cintre en bois antivol



Numéro en adhésif  
résine avec logo Fit  
Interiors



Numéro perforé sur  
plaque d'acier



Numéro gravé sur  
plaque d'acier



Nombre découpé  
sur plaque d'acier



Plinthe argent



Plinthe blanc

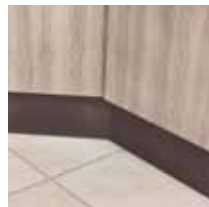

Plinthe noir

# Atelier

## Medidas

- De una columna: L 450 mm / P 550 mm / H 2100 mm
- Altura total con el rodapié: 2170 mm

## Características generales

- Armario de paneles de fibra de madera grosor 18 mm, bordes de ABS con cola poliuretánica
- Dos rejillas de ventilación por receptáculo
- Barra percha o gancho por receptáculo
- Pies graduables
- Bisagras certificadas para 80.000 ciclos de apertura y cierre
- Cerradura de llave (con 2 llaves + pulsera para llave numerada) o con candado

## Características específicas

- Taquillas de una columna
- Hoja de fibra de madera de varios acabados madera (ver The Swatch Book)
- Estructura interna de dos colores de madera: antracita o cachemira
- Bisagras con amortiguación
- Ángulo de apertura de la hoja 170°
- Dos perchas por receptáculo
- Número por hoja de adhesivo resinado con logo Fit Interiors

## Opcional disponible bajo pedido

- Otros tipos de cerradura (mecánica o electrónica)
- Tiradores a elegir entre todos los tipos
- Otros tipos de número
- Rodapiés de tres colores: plateado, negro, blanco
- Portadocumentos
- Espejo
- Cesto para objetos
- Toma USB
- Top o top con LED
- Paneles laterales terminales o paneles laterales terminales con LED
- Percha antirrobo de madera

### ANTA

MADERA + ACABADOS



### CASSA

MADERA + ACABADOS



ANTRACITA



CACHEMIRA







**ANBo1-19**

Armario 1 hoja

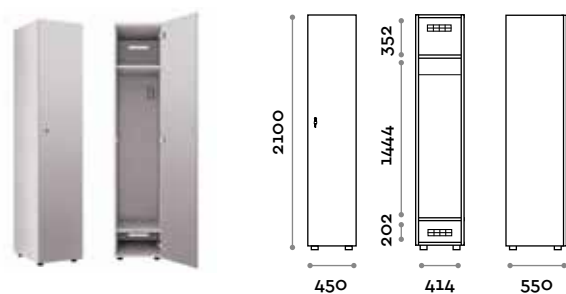

**ANB11-19**

Armario 1 hoja por banco

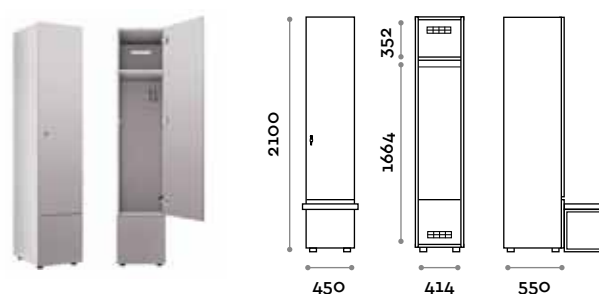

**ANBo2-19**

Armario 2 hojas

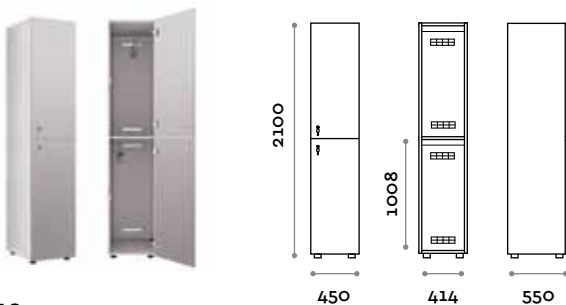

**ANB12-19**

Armario 2 hojas por banco

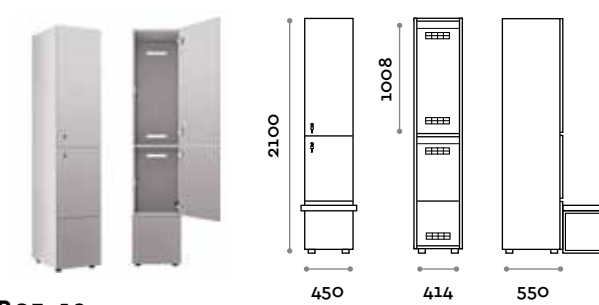

**ANBo3-19**

Armario 2 hojas en "L"

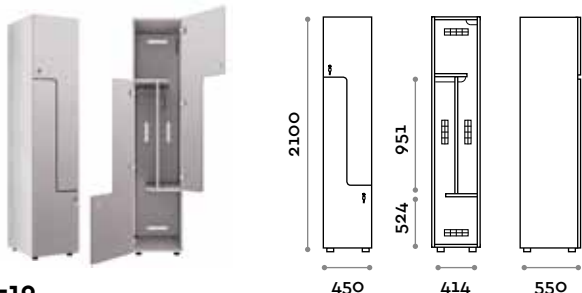

**ANBo5-19**

Armario 5 hojas

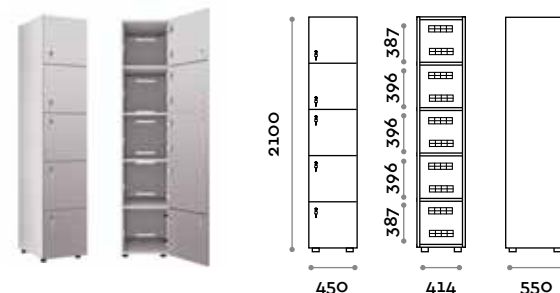

**ATRO2-19**

Armario 2 hojas trapezoidales

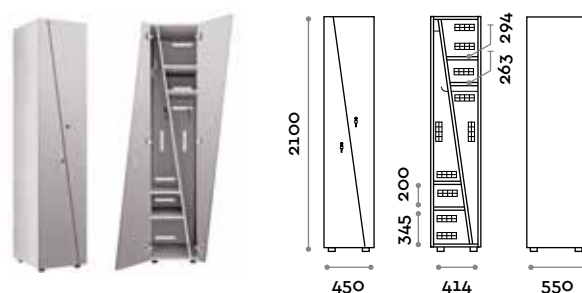



## Tiradores

### HAN 01

Tirador de zamak

Medidas

L 10 mm / P 30 mm / H 106 mm



Cromo brillante

Cromo mate

### HAN 02

Pomo de zamak

Medidas

Ø 20 mm / P 25 mm

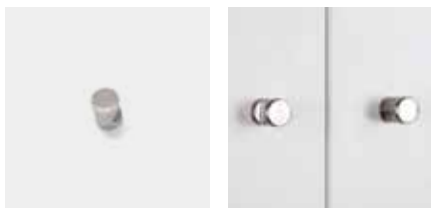

Cromo brillante

### HAN 03

Tirador de zamak

Medidas

L 42 mm / P 12 mm / H 106 mm

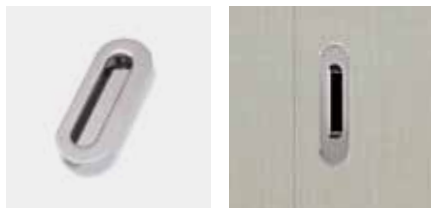

Cromo brillante

### HAN 04

Tirador de zamak

Medidas

L 50 mm / P 25,7 mm / H 80 mm



titanio

### HAN 05

Tirador de zamak

Medidas

L 22 mm / P 18 mm / H 158 mm



Cromo brillante

blanco

antracita

### HAN 06

Tirador de aluminio

Medidas

L 16 mm / P 36 mm / H 198 mm



anodizado brillante

### HAN 07

Maniglia in zama

Medidas

L 69 mm / P 26 mm / H 69 mm



Cromo brillante

### HAN 08

Pomo de plástico

Medidas

Ø 35 mm / P 28 mm



plateado brillante

plateado mate

## Cerraduras

### Incluidas



Con candado



Llave

### Opcionales bajo pedido



**ACCMON**  
Cerradura moneda

### Cerradura digital con batería



**ACCXVER**  
Axis vertical



**ACCDLKN**  
Next CUE



**ACCXSTD**  
Axis standard



**ACCDKSO**  
Solag

### Cerradura de proximidad



**ACCXSTDRFID**  
Axis standard



**ACCXVERRFID**  
Axis vertical



**ACCDLKNRFID**  
next cue



**ACCOJPRO**  
Ojmar



**ACCGAT**  
mod. 7010

### Cerradura de combinación mecánica



**ACCCOMBI**  
Combi Lock



**ACCDKDI**  
Digilock DIAL



**ACCKEYLESS**  
P1

## Accesorios

### Incluidos



**ACCAPP**  
Percha de plástico

### Opcionales bajo pedido



**ACCDOC**  
Portadocumentos



**ACCSP**  
Espejo

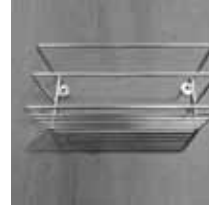

**ACCES**  
Cesto



**ACCUSB**  
Toma USB



**ACCTOP**  
Top



**ACCTAM**  
Paneles laterales



**ACCGRU**  
Percha antirrobo de madera



Número de adhesivo  
resinado con logo Fit  
Interiors



Número perforado  
en placa de acero



Número grabado en  
placa de acero



Número cortado en  
placa de acero



Rodapiés plateado



Rodapiés blanco

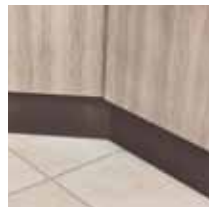

Rodapiés negro

follow us



## Fit Interiors

Gruppo P&G srl  
Via Emilia, n.3916  
47020 Longiano (FC), Italy  
tel. (+39) 0547 58746  
info@gruppoppeg.com



**fit**  
**interiors**

furniture for health  
and golf clubs, gyms  
hotel&spa, medical  
and corporate

visit [www.fitinteriors.com](http://www.fitinteriors.com)