

DESIGN FIRST.

iridic road

fit interiors

fit interiors — designed and produced in italy

Nordic

Italiano	3
English	5
Deutsch	7
Français	9
Español	11

Nordic

Alberto Manzoni

Bancone modulare con doghe in massello di frassino, struttura in MFC sp.18 mm. Top, piano e fascia inferiore sp.36 mm, con led a luce naturale 4000 k°. Piano di lavoro con n°2 passacavi in metallo.



Struttura

Finiture



Doghe

Massello frassino



Naturale



Wengé

Piano di lavoro

Finiture



Antracite



Cashemire



Nero opaco



Bianco opaco

modulo angolo squadrato
NOAS76 / NOAS90

modulo terminale SX
NO09076S / NO09090S

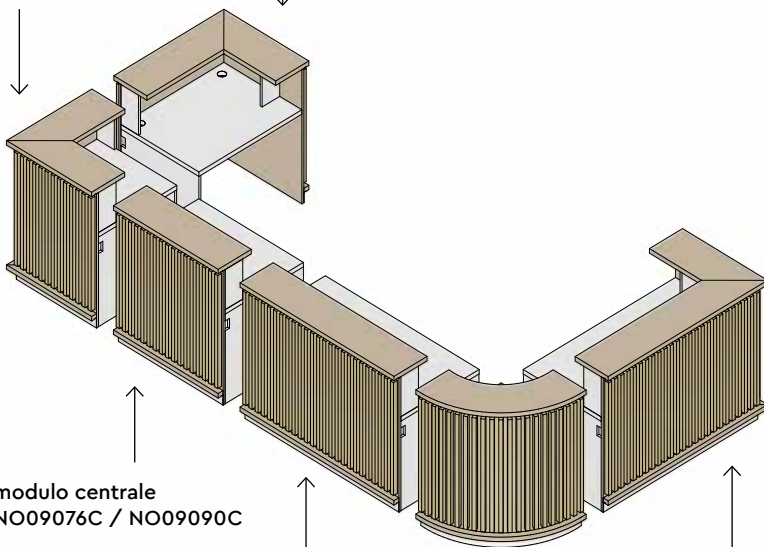

modulo centrale
NO09076C / NO09090C

modulo centrale
NO14076C / NO14090C

modulo angolo curvo
NOAC76 / NOAC90

modulo terminale DX
NO14076D / NO14090D

Alcune possibili combinazioni

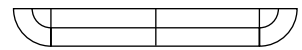

A

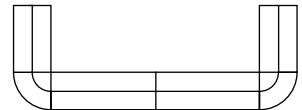

B

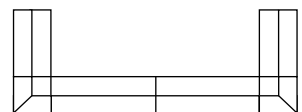

C

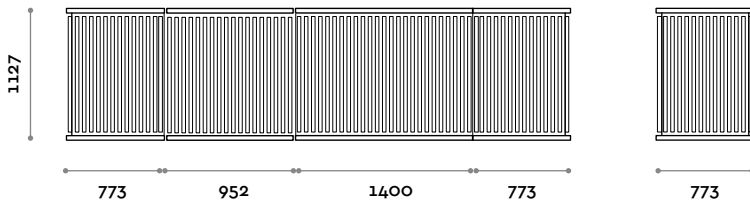

NO14076S

Modulo 140 terminale SX. Altezza piano di lavoro 778 mm
L 1445 mm / P 773 mm / H 1127 mm



NO14090S

Modulo 140 terminale SX. Altezza piano di lavoro 918 mm
L 1445 mm / P 773 mm / H 1127 mm



NO14076D

Modulo 140 terminale DX. Altezza piano di lavoro 778 mm
L 1445 mm / P 773 mm / H 1127 mm



NO14090D

Modulo 140 terminale DX. Altezza piano di lavoro 918 mm
L 1445 mm / P 773 mm / H 1127 mm



NO14076C

Modulo 140 centrale. Altezza piano di lavoro 778 mm
L 1400 mm / P 773 mm / H 1127 mm



NO14090C

Modulo 140 centrale. Altezza piano di lavoro 918 mm
L 1400 mm / P 773 mm / H 1127 mm



NO09076C

Modulo 90 centrale. Altezza piano di lavoro 778 mm
L 952 mm / P 773 mm / H 1127 mm



NO09090C

Modulo 90 centrale. Altezza piano di lavoro 918 mm
L 952 mm / P 773 mm / H 1127 mm



NO09076S

Modulo 90 terminale SX. Altezza piano di lavoro 778 mm
L 997 mm / P 773 mm / H 1127 mm



NO09090S

Modulo 90 terminale SX. Altezza piano di lavoro 918 mm
L 997 mm / P 773 mm / H 1127 mm



NO09076D

Modulo 90 terminale DX. Altezza piano di lavoro 778 mm
L 997 mm / P 773 mm / H 1127 mm



NO09090D

Modulo 90 terminale DX. Altezza piano di lavoro 918 mm
L 997 mm / P 773 mm / H 1127 mm



NOAS76

Modulo angolo squadrato. Altezza piano di lavoro 778 mm
L 773 mm / P 773 mm / H 1127 mm



NOAS90

Modulo angolo squadrato. Altezza piano di lavoro 918 mm
L 773 mm / P 773 mm / H 1127 mm



NOAC76

Modulo angolo curvo. Altezza piano di lavoro 778 mm
L 773 mm / P 773 mm / H 1127 mm



NOAC90

Modulo angolo curvo. Altezza piano di lavoro 918 mm
L 773 mm / P 773 mm / H 1127 mm

Nordic

Alberto Manzoni

Modular counter with solid ash slats, MFC structure 18 mm thickness. Top, worktop and lower band 36 mm thickness with 4000 k° natural white LED light. Worktop has 2 metal cable grommets.



Structure

Finishes



Slats

Solid ash wood



Worktop

Finishes



square corner module
NOAS76 / NOAS90

left end module
NO09076S / NO09090S

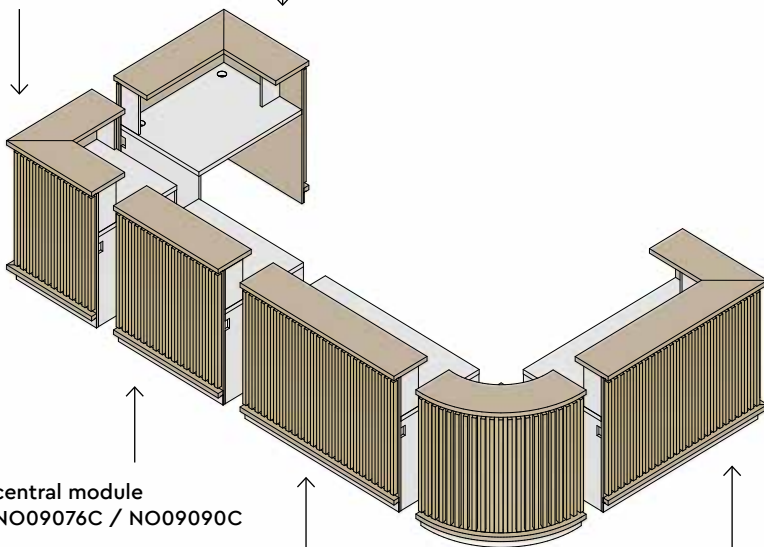

central module
NO09076C / NO09090C

central module
NO14076C / NO14090C

curved corner module
NOAC76 / NOAC90

right end module
NO14076D / NO14090D

Example compositions

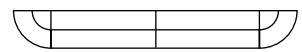

A

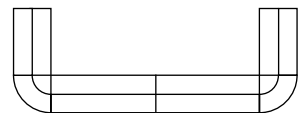

B

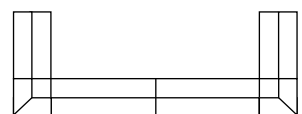

C

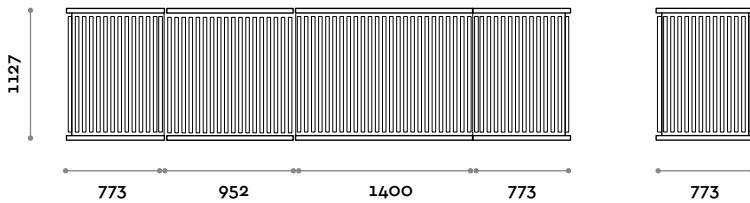

NO14076S
 Left end module 140. Worktop height 778 mm
 W 1445 mm / D 773 mm / H 1127 mm



NO14090S
 Left end module 140. Worktop height 918 mm
 W 1445 mm / D 773 mm / H 1127 mm



NO14076D
 Right end module 140. Worktop height 778 mm
 W 1445 mm / D 773 mm / H 1127 mm



NO14090D
 Right end module 140. Worktop height 918 mm
 W 1445 mm / D 773 mm / H 1127 mm



NO14076C
 Central module 140. Worktop height 778 mm
 W 1400 mm / D 773 mm / H 1127 mm



NO14090C
 Central module 140. Worktop height 918 mm
 W 1400 mm / D 773 mm / H 1127 mm



NO09076C
 Central module 90. Worktop height 778 mm
 W 952 mm / D 773 mm / H 1127 mm



NO09090C
 Central module 90. Worktop height 918 mm
 W 952 mm / D 773 mm / H 1127 mm



NO09076S
 Left end module 90. Worktop height 778 mm
 W 997 mm / D 773 mm / H 1127 mm



NO09090S
 Left end module 90. Worktop height 918 mm
 W 997 mm / D 773 mm / H 1127 mm



NO09076D
 Right end module 90. Worktop height 778 mm
 W 997 mm / D 773 mm / H 1127 mm



NO09090D
 Right end module 90. Worktop height 918 mm
 W 997 mm / D 773 mm / H 1127 mm



NOAS76
 Square corner module. Worktop height 778 mm
 W 773 mm / D 773 mm / H 1127 mm



NOAS90
 Square corner module. Worktop height 918 mm
 W 773 mm / D 773 mm / H 1127 mm



NOAC76
 Curved corner module. Worktop height 778 mm
 W 773 mm / D 773 mm / H 1127 mm



NOAC90
 Curved corner module. Worktop height 918 mm
 W 773 mm / D 773 mm / H 1127 mm

Nordic

Alberto Manzoni

Modulare Theke mit Leisten aus Eschen-Massivholz und furnierter Struktur von 18 mm Stärke Top, Arbeitsplatte und unterer Abschlussstreifen von 36 mm Stärke, mit LED für natürliches Licht 4000 k°. Arbeitsplatte mit 2 Kabeldurchführungen aus Metall.



Struktur

Ausführungen



Leisten

Eschen-massivholz



Arbeitsplatte

Ausführungen



abgewinkeltes Eckmodul
NOAS76 / NOAS90

Abschlussmodul links
NO09076S / NO09090S

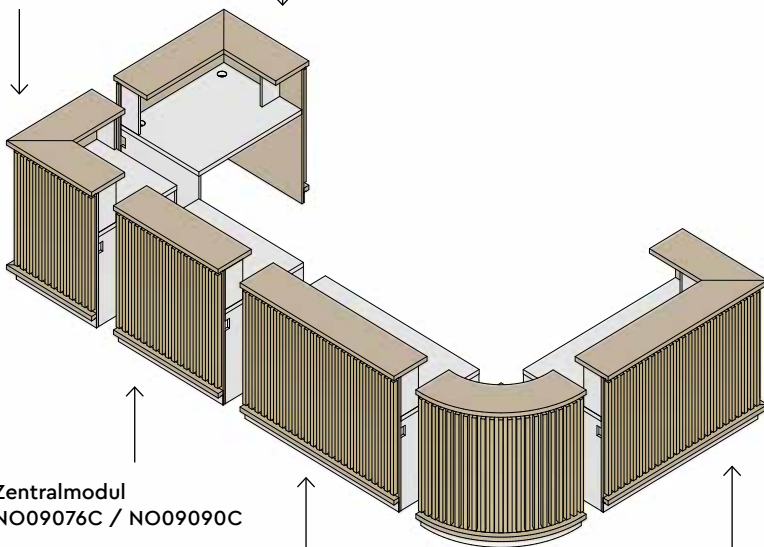

Zentralmodul
NO09076C / NO09090C

Zentralmodul
NO14076C / NO14090C

gebogenes Eckmodul
NOAC76 / NOAC90

Abschlussmodul rechts
NO14076D / NO14090D

Einige mögliche Kombinationen

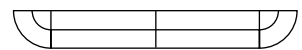

A

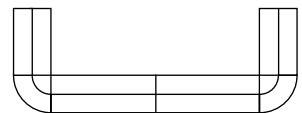

B

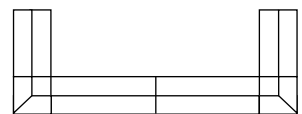

C

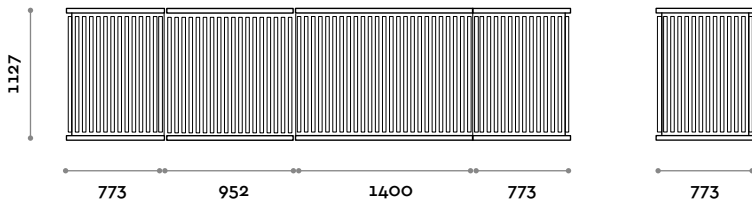
**NO14076S**

Abschlussmodul links 140. Arbeitsplattenhöhe 778 mm
B 1445 mm / T 773 mm / H 1127 mm

**NO14090S**

Abschlussmodul links 140. Arbeitsplattenhöhe 918 mm
B 1445 mm / T 773 mm / H 1127 mm

**NO14076D**

Abschlussmodul rechts 140. Arbeitsplattenhöhe 778 mm
B 1445 mm / T 773 mm / H 1127 mm

**NO14090D**

Abschlussmodul rechts 140. Arbeitsplattenhöhe 918 mm
B 1445 mm / T 773 mm / H 1127 mm

**NO14076C**

Zentralmodul 140. Arbeitsplattenhöhe mm
B 1400 mm / T 773 mm / H 1127 mm

**NO14090C**

Zentralmodul 140. Arbeitsplattenhöhe 918 mm
B 1400 mm / T 773 mm / H 1127 mm

**NO09076C**

Zentralmodul 90. Arbeitsplattenhöhe 778 mm
B 952 mm / T 773 mm / H 1127 mm

**NO09090C**

Zentralmodul 90. Arbeitsplattenhöhe 918 mm
B 952 mm / T 773 mm / H 1127 mm

**NO09076S**

Abschlussmodul links 90. Arbeitsplattenhöhe 778 mm
B 997 mm / T 773 mm / H 1127 mm

**NO09090S**

Abschlussmodul links 90. Arbeitsplattenhöhe 918 mm
B 997 mm / T 773 mm / H 1127 mm

**NO09076D**

Abschlussmodul rechts 90. Arbeitsplattenhöhe 778 mm
B 997 mm / T 773 mm / H 1127 mm

**NO09090D**

Abschlussmodul rechts 90. Arbeitsplattenhöhe 918 mm
B 997 mm / T 773 mm / H 1127 mm

**NOAS76**

Abgewinkelt Eckmodul. Arbeitsplattenhöhe 778 mm
B 773 mm / T 773 mm / H 1127 mm

**NOAS90**

Abgewinkelt Eckmodul. Arbeitsplattenhöhe 918 mm
B 773 mm / T 773 mm / H 1127 mm

**NOAC76**

Gebogenes Eckmodul. Arbeitsplattenhöhe 778 mm
B 773 mm / T 773 mm / H 1127 mm

**NOAC90**

Gebogenes Eckmodul. Arbeitsplattenhöhe 918 mm
B 773 mm / T 773 mm / H 1127 mm

Nordic

Alberto Manzoni

Comptoir modulaire avec lattes en frêne massif, structure en mélaminé 18 mm d'épaisseur. Dessus, plan et bande inférieure de 36 mm d'épaisseur, avec led à lumière naturelle 4000 K°. Plan de travail avec 2 goulottes en métal.



Structure

Finitions



Lattes

Frêne massif



Naturel



Wengé

Plan de travail

Finitions



Anthracite



Cachemire



Noir mat



Blanc mat

module d'angle carré
NOAS76 / NOAS90

module d'extrémité gauche
NO09076S / NO09090S

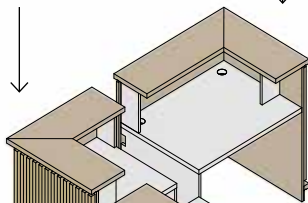

module central
NO09076C / NO09090C

module central
NO14076C / NO14090C

module d'angle courbe
NOAC76 / NOAC90

module d'extrémité droit
NO14076D / NO14090D

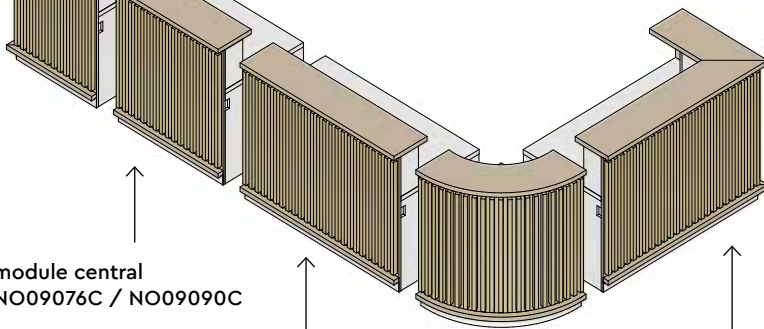

Quelques combinaisons possibles

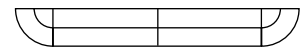

A

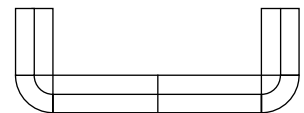

B

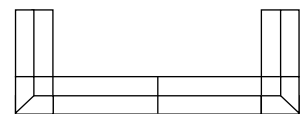

C

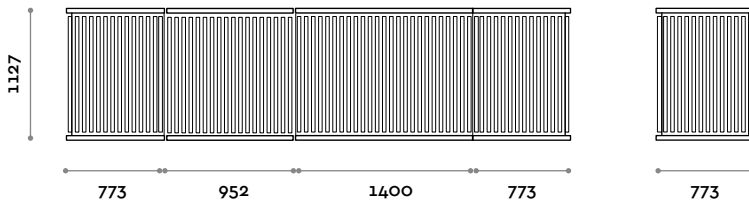
**NO14076S**

Module d'extrémité gauche 140. Hauteur du plan de travail 778 mm
L 1445 mm / P 773 mm / H 1127 mm

**NO14090S**

Module d'extrémité gauche 140. Hauteur du plan de travail 918 mm
L 1445 mm / P 773 mm / H 1127 mm

**NO14076D**

Module d'extrémité droite 140. Hauteur du plan de travail 778 mm
L 1445 mm / P 773 mm / H 1127 mm

**NO14090D**

Module d'extrémité droite 140. Hauteur du plan de travail 918 mm
L 1445 mm / P 773 mm / H 1127 mm

**NO14076C**

Module central 140. Hauteur du plan de travail 778 mm
L 1400 mm / P 773 mm / H 1127 mm

**NO14090C**

Module central 140. Hauteur du plan de travail 918 mm
L 1400 mm / P 773 mm / H 1127 mm

**NO09076C**

Module central 90. Hauteur du plan de travail 778 mm
L 952 mm / P 773 mm / H 1127 mm

**NO09090C**

Module central 90. Hauteur du plan de travail 918 mm
L 952 mm / P 773 mm / H 1127 mm

**NO09076S**

Module d'extrémité gauche 90. Hauteur du plan de travail 778 mm
L 997 mm / P 773 mm / H 1127 mm

**NO09090S**

Module d'extrémité gauche 90. Hauteur du plan de travail 918 mm
L 997 mm / P 773 mm / H 1127 mm

**NO09076D**

Module d'extrémité droite 90. Hauteur du plan de travail 778 mm
L 997 mm / P 773 mm / H 1127 mm

**NO09090D**

Module d'extrémité droite 90. Hauteur du plan de travail 918 mm
L 997 mm / P 773 mm / H 1127 mm

**NOAS76**

Module d'angle carré. Hauteur du plan de travail 778 mm
L 773 mm / P 773 mm / H 1127 mm

**NOAS90**

Module d'angle carré. Hauteur du plan de travail 918 mm
L 773 mm / P 773 mm / H 1127 mm

**NOAC76**

Module d'angle courbe. Hauteur du plan de travail 778 mm
L 773 mm / P 773 mm / H 1127 mm

**NOAC90**

Module d'angle courbe. Hauteur du plan de travail 918 mm
L 773 mm / P 773 mm / H 1127 mm

Nordic

Alberto Manzoni

Mostrador modular con duelas de madera maciza de fresno, estructura de ennoblecido grosor 18 mm. Top, superficie y faja inferior grosor 36 mm, con led de luz natural 4.000 k°. Encimera con 2 pasacables de metal.



Estructura

Acabados



Duelas

Madera maciza de fresno



Encimera

Acabados



módulo ángulo recto
NOAS76 / NOAS90

módulo terminal IZQ
NO09076S / NO09090S

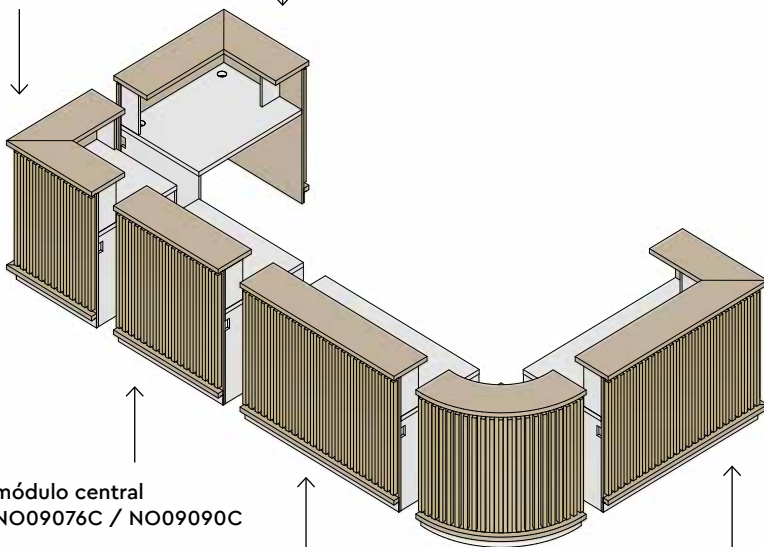

módulo central
NO09076C / NO09090C

módulo central
NO14076C / NO14090C

módulo ángulo curvado
NOAC76 / NOAC90

módulo terminal DCHA
NO14076D / NO14090D

Varias posibles combinaciones

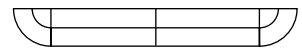

A

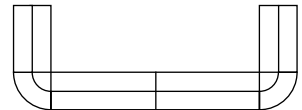

B

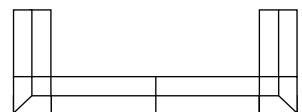

C

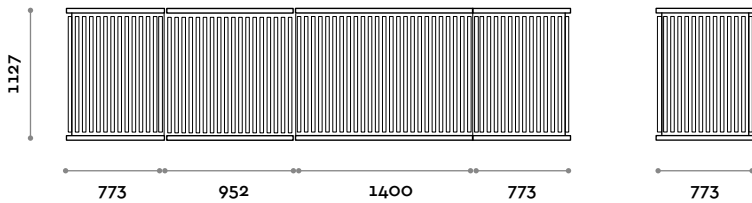

NO14076S
Módulo terminal IZQ 140. Altura encimera 778 mm
L 1445 mm / P 773 mm / H 1127 mm



NO14090S
Módulo terminal IZQ 140. Altura encimera 918 mm
L 1445 mm / P 773 mm / H 1127 mm



NO14076D
Modulo terminal DCHA 140. Altura encimera 778 mm
L 1445 mm / P 773 mm / H 1127 mm



NO14090D
Modulo terminal DCHA 140. Altura encimera 918 mm
L 1445 mm / P 773 mm / H 1127 mm



NO14076C
Módulo central 140. Altura encimera 778 mm
L 1400 mm / P 773 mm / H 1127 mm



NO14090C
Módulo central 140. Altura encimera 918 mm
L 1400 mm / P 773 mm / H 1127 mm



NO09076C
Módulo central 90. Altura encimera 778 mm
L 952 mm / P 773 mm / H 1127 mm



NO09090C
Módulo central 90. Altura encimera 918 mm
L 952 mm / P 773 mm / H 1127 mm



NO09076S
Módulo terminal IZQ 90. Altura encimera 778 mm
L 997 mm / P 773 mm / H 1127 mm



NO09090S
Módulo terminal IZQ 90. Altura encimera 918 mm
L 997 mm / P 773 mm / H 1127 mm



NO09076D
Modulo terminal DCHA 90. Altura encimera 778 mm
L 997 mm / P 773 mm / H 1127 mm



NO09090D
Modulo terminal DCHA 90. Altura encimera 918 mm
L 997 mm / P 773 mm / H 1127 mm



NOAS76
Módulo ángulo recto. Altura encimera 778 mm
L 773 mm / P 773 mm / H 1127 mm



NOAS90
Módulo ángulo recto. Altura encimera 918 mm
L 773 mm / P 773 mm / H 1127 mm



NOAC76
Modulo ángulo curvado. Altura encimera 778 mm
L 773 mm / P 773 mm / H 1127 mm



NOAC90
Modulo ángulo curvado. Altura encimera 918 mm
L 773 mm / P 773 mm / H 1127 mm

follow us



Fit Interiors

Gruppo P&G srl
Via Emilia, n.3916
47020 Longiano (FC), Italy
tel. (+39) 0547 58746
info@gruppopeg.com



fit
interiors

furniture for health
and golf clubs, gyms
hotel&spa, medical
and corporate

visit www.fitinteriors.com