

DESIGN FIRST.

Sq

wa

re

—

**fit interiors**

# Square

Italiano	3
English	6
Deutsch	9
Français	12
Español	15

# Square

Bancone modulare in MFC e laminato con luci LED.

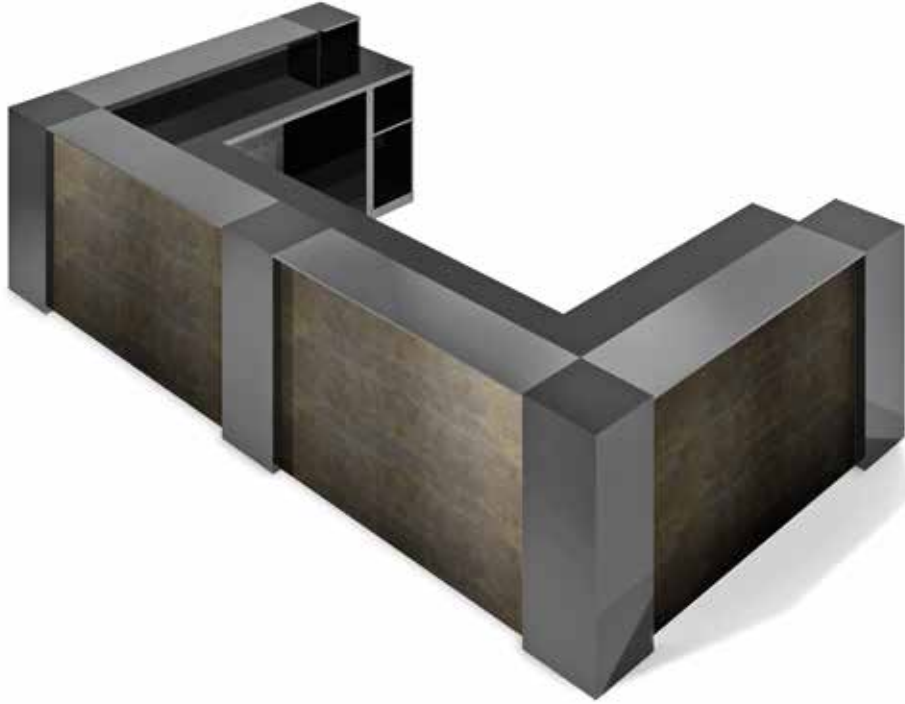

## Struttura

Finiture



## Piano di lavoro

Finiture

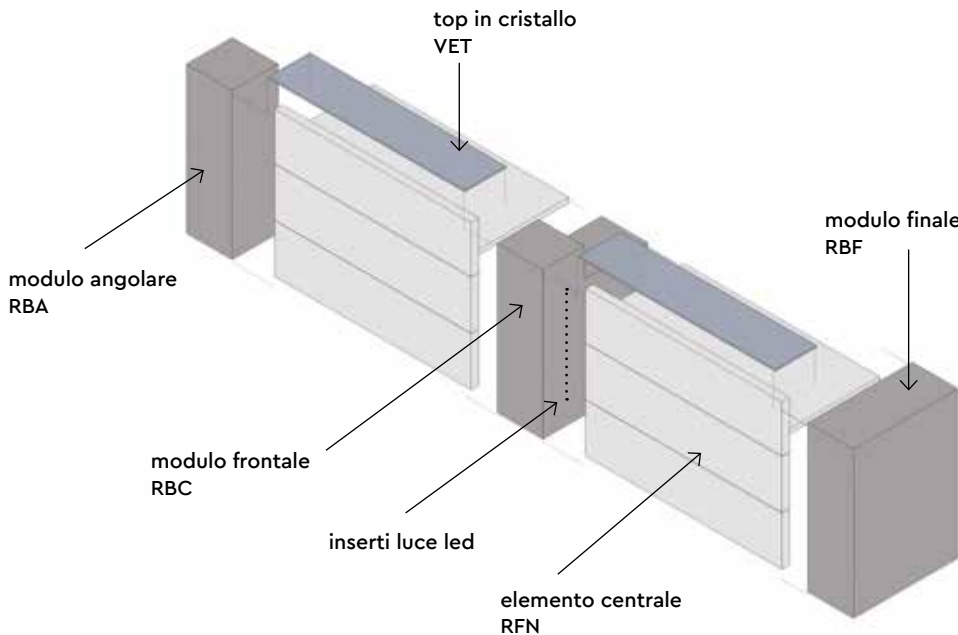

Alcune possibili combinazioni

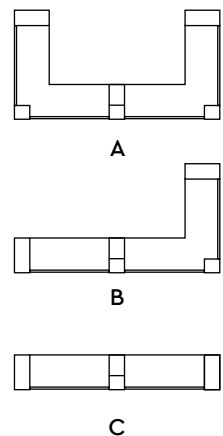

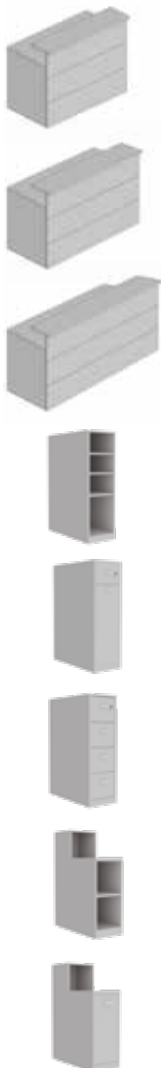
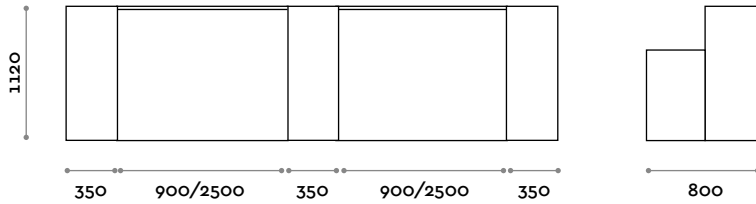

**RFN001**

Fronte con top in nobilitato. Altezza piano di lavoro 778 mm / 918 mm  
L 900-1300 mm / P 800 mm / H 1120 mm

**RFN002**

Fronte con top in nobilitato. Altezza piano di lavoro 778 mm / 918 mm  
L 1301-1900 mm / P 800 mm / H 1120 mm

**RFN003**

Fronte con top in nobilitato. Altezza piano di lavoro 778 mm / 918 mm  
L 1901-2500 mm / P 800 mm / H 1120 mm

**RBF001**

Modulo finale in laminato con vani a giorno e due ripiani mobili  
L 350 mm / P 800 mm / H 1120 mm

**RBF002**

Modulo finale in laminato con 1 cassetto ed 1 anta con ripiano interno mobile  
L 350 mm / P 800 mm / H 1120 mm

**RBF003**

Modulo finale in laminato con 4 cassette  
L 350 mm / P 800 mm / H 1120 mm

**RBC001**

Modulo centrale in laminato con vani a giorno e ripiano mobile  
L 350 mm / P 800 mm / H 1120 mm

**RBC002**

Modulo centrale in laminato, 1 vano a giorno e 1 anta con ripiano interno mobile  
L 350 mm / P 800 mm / H 1120 mm

**RBC003**

Modulo centrale in laminato con 1 vano a giorno e 3 cassetti  
L 350 mm / P 800 mm / H 1120 mm

**RBA001**

Modulo per angolo chiuso in laminato  
L 350 mm / P 350 mm / H 1120 mm

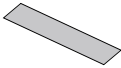
**VET001**

Top in vetro temperato retrolaccato  
L 900 - 1300 mm / P 350 mm / H 12 mm

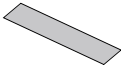
**VET002**

Top in vetro temperato retrolaccato  
L 1301 - 1900 mm / P 350 mm / H 12 mm

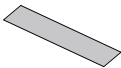
**VET003**

Top in vetro temperato retrolaccato  
L 1901 - 2500 mm / P 350 mm / H 12 mm

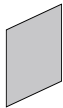
**LOG100**

Vetro frontale con logo serigrafato cm 100  
L fino a 1000 mm / P 18 mm / H 1120 mm

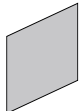
**LOG150**

Vetro frontale con logo serigrafato cm 150  
L 1001 - 1500 mm / P 18 mm / H 1120 mm

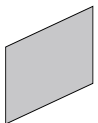
**LOG200**

Vetro frontale con logo serigrafato cm 200  
L 1501 - 2000 mm / P 18 mm / H 1120 mm

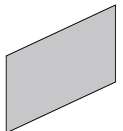
**LOG250**

Vetro frontale con logo serigrafato cm 250  
L 2001 - 2500 mm / P 18 mm / H 1120 mm

**RGB250**

Led RGB sui due lati della torretta  
(R) 4,8W per metro, 12 V

**LED250**

Led sui due lati della torretta IP20  
(C) 6000 K / 4,8W per metro, 24 V  
(N) 4000 K / 4,8W per metro, 24 V  
(N) 3000 K / 4,8W per metro, 24 V

# Square

Modular counter made of MFC and laminate with LED lighting.

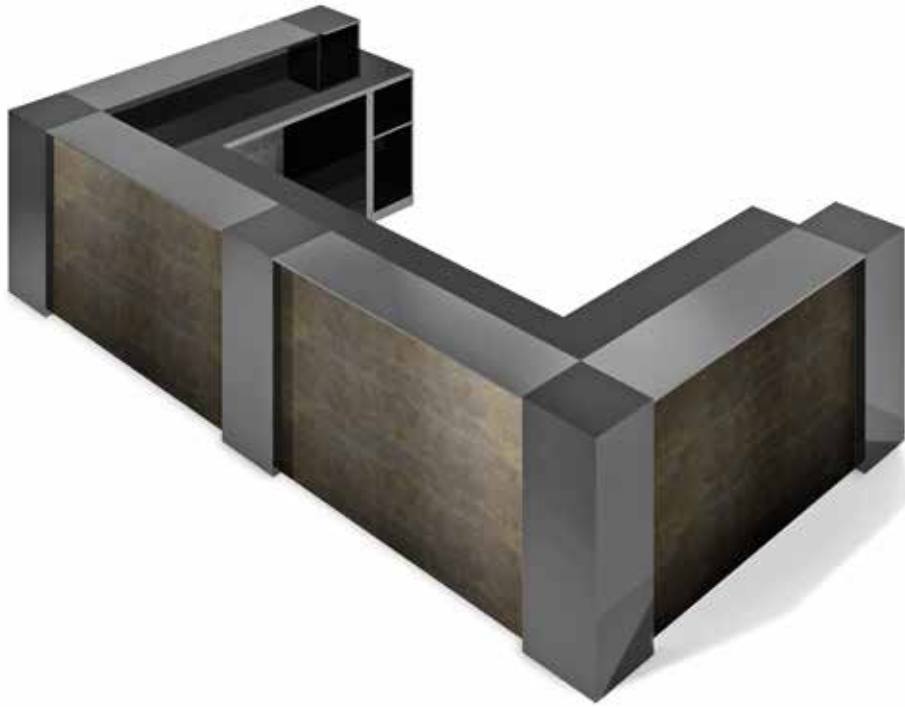

## Structure

Finishes



## Worktop

Finishes

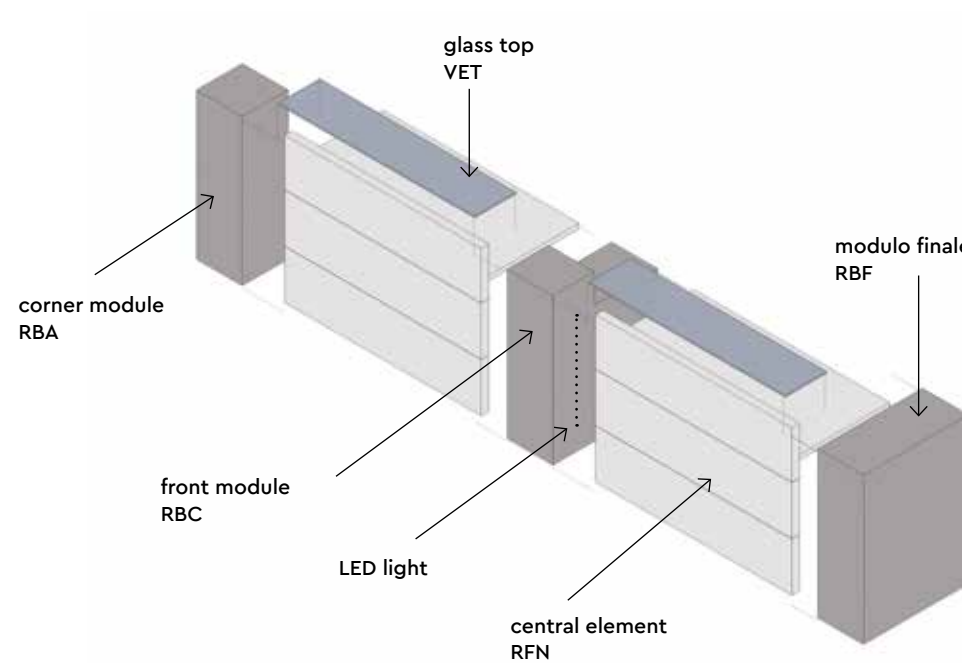

## Example compositions

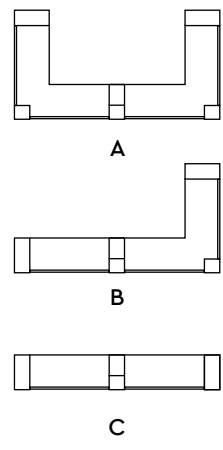

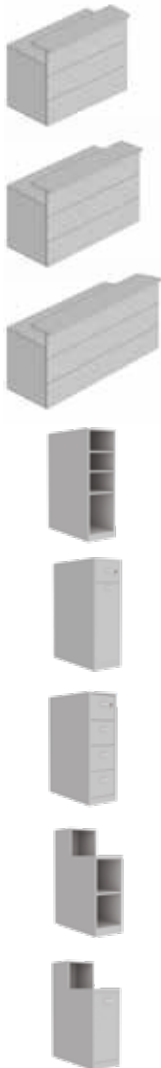
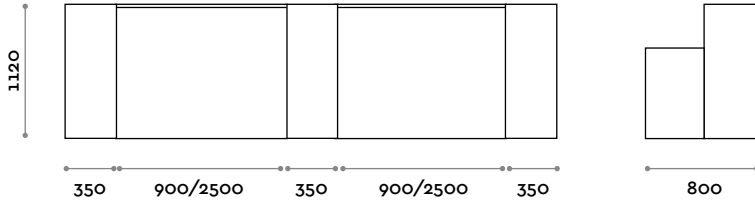

**RFN001**

Front and top made in MFC. Worktop height 778 mm / 918 mm  
W 900-1300 mm / D 800 mm / H 1120 mm

**RFN002**

Front and top made in MFC. Worktop height 778 mm / 918 mm  
W 1301-1900 mm / D 800 mm / H 1120 mm

**RFN003**

Front and top made in MFC. Worktop height 778 mm / 918 mm  
W 1901-2500 mm / D 800 mm / H 1120 mm

**RBF001**

Laminate end tower with open compartments and two removable shelves  
W 350 mm / D 800 mm / H 1120 mm

**RBF002**

Laminate end tower with 1 drawer and 1 door with removable shelf inside  
W 350 mm / D 800 mm / H 1120 mm

**RBF003**

Laminate end tower with 4 drawers  
W 350 mm / D 800 mm / H 1120 mm

**RBC001**

Laminate central tower with open compartments and removable shelf  
W 350 mm / D 800 mm / H 1120 mm

**RBC002**

Laminate central tower with 1 drawer and 1 door with removable shelf inside  
W 350 mm / D 800 mm / H 1120 mm



**RBC003**

Laminate central tower with 1 open compartment and 3 drawers  
W 350 mm / D 800 mm / H 1120 mm



**RBA001**

Laminate corner tower  
W 350 mm / D 350 mm / H 1120 mm

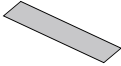

**VET001**

Top in tempered backlaquered glass  
W 900 - 1300 mm / D 350 mm / H 12 mm

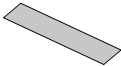

**VET002**

Top in tempered backlaquered glass  
W 1301 - 1900 mm / D 350 mm / H 12 mm

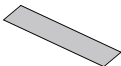

**VET003**

Top in tempered backlaquered glass  
W 1901 - 2500 mm / D 350 mm / H 12 mm

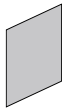

**LOG100**

Front glass with logo cm 100  
W up to 1000 mm / D 18 mm / H 1120 mm

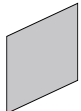

**LOG150**

Front glass with logo cm 150  
W 1001 - 1500 mm / D 18 mm / H 1120 mm

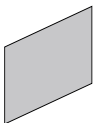

**LOG200**

Front glass with logo cm 200  
W 1501 - 2000 mm / D 18 mm / H 1120 mm

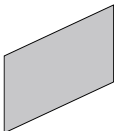

**LOG250**

Front glass with logo cm 250  
W 2001 - 2500 mm / D 18 mm / H 1120 mm



**RGB250**

RGB LED lights on both sides of tower  
(R) 4,8W per meter, 12 V



**LED250**

LED lights on both sides of tower IP20  
(C) 6000 K / 4,8W per meter, 24 V  
(N) 4000 K / 4,8W per meter, 24 V  
(N) 3000 K / 4,8W per meter, 24 V



# Square

Modulare Theke aus MFC und Laminat mit LED-Beleuchtung.

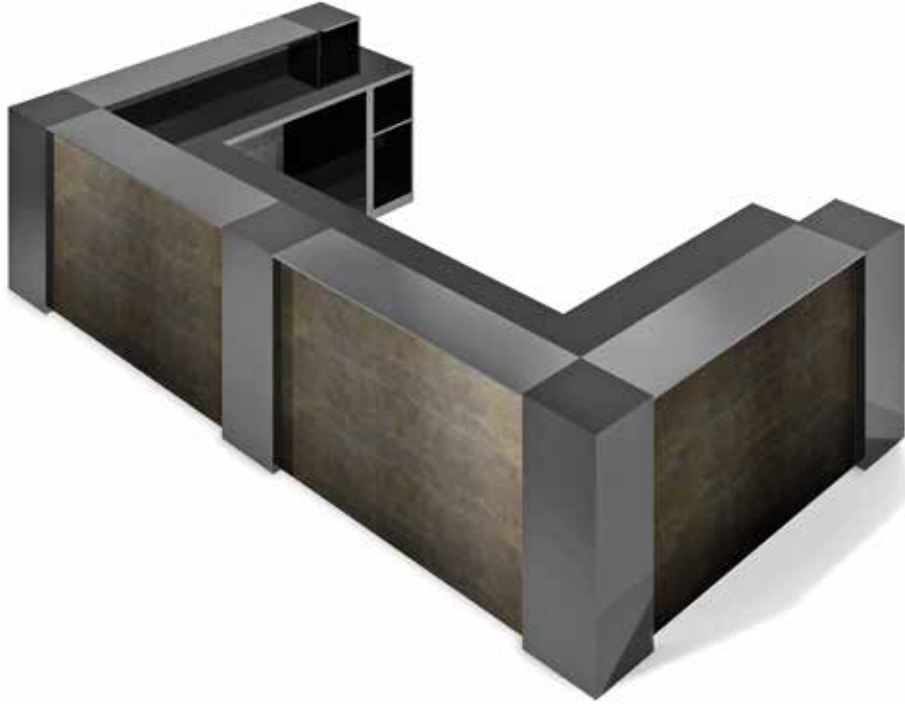

## Struktur

Ausführungen



## Arbeitsplatte

Ausführungen

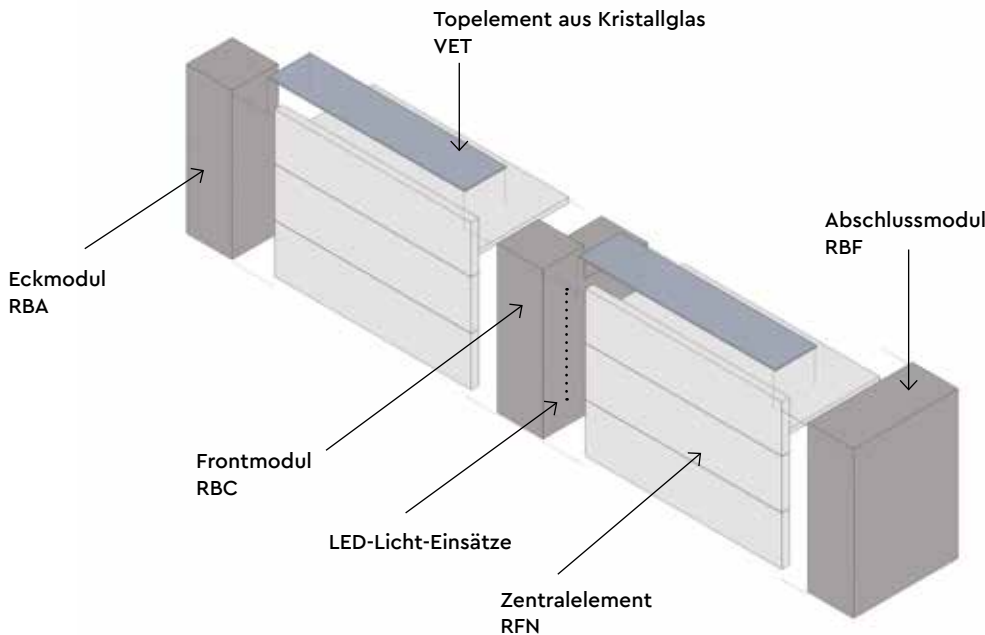

Einige mögliche Kombinationen

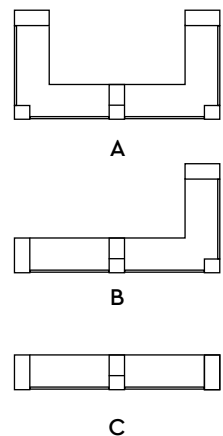

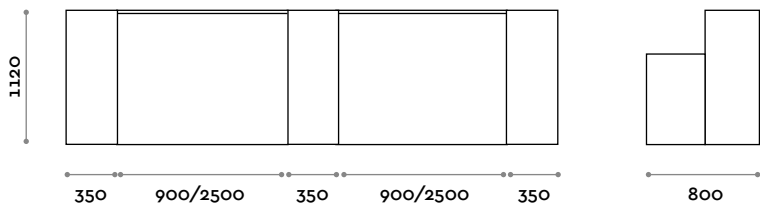

**RFN001**

Frontelement und Arbeitsfläche furniert. Arbeitsplattenhöhe 778 mm / 918 mm  
 B 900-1300 mm / T 800 mm / H 1120 mm



**RFN002**

Frontelement und Arbeitsfläche furniert. Arbeitsplattenhöhe 778 mm / 918 mm  
 B 1301-1900 mm / T 800 mm / H 1120 mm



**RFN003**

Frontelement und Arbeitsfläche furniert. Arbeitsplattenhöhe 778 mm / 918 mm  
 B 1901-2500 mm / T 800 mm / H 1120 mm



**RBF001**

Abschlussmodul aus Laminat mit Stauräumen und zwei beweglichen Innenborden  
 B 350 mm / T 800 mm / H 1120 mm



**RBF002**

Abschlussmodul aus Laminat mit 1 Schublade, 1 Tür und beweglichem Innenbord  
 B 350 mm / T 800 mm / H 1120 mm



**RBF003**

Abschlussmodul aus Laminat mit 4 Schubladen  
 B 350 mm / T 800 mm / H 1120 mm



**RBC001**

Zentralmodul aus Laminat mit Stauräumen und beweglichem Innenbord  
 B 350 mm / T 800 mm / H 1120 mm



**RBC002**

Zentralmodul aus Laminat mit 1 Stauraum, 1 Tür und beweglichem Innenbord  
 B 350 mm / T 800 mm / H 1120 mm

**RBC003**

Zentralmodul aus Laminat mit 1 Stauraum und 3 Schubladen  
B 350 mm / T 800 mm / H 1120 mm

**RBA001**

Geschlossenes Eckmodul aus Laminat  
B 350 mm / T 350 mm / H 1120 mm

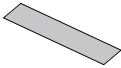
**VET001**

Topelement aus gehärtetem, rückseitig lackiertem Glas  
B 900 - 1300 mm / T 350 mm / H 12 mm

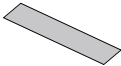
**VET002**

Topelement aus gehärtetem, rückseitig lackiertem Glas  
B 1301 - 1900 mm / T 350 mm / H 12 mm

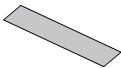
**VET003**

Topelement aus gehärtetem, rückseitig lackiertem Glas  
B 1901 - 2500 mm / T 350 mm / H 12 mm

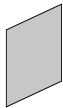
**LOG100**

Frontglas mit Logo cm 100  
B bis 1000 mm / T 18 mm / H 1120 mm

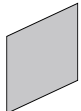
**LOG150**

Frontglas mit Logo cm 150  
B 1001 - 1500 mm / T 18 mm / H 1120 mm

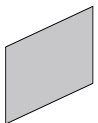
**LOG200**

Frontglas mit Logo cm 200  
B 1501 - 2000 mm / T 18 mm / H 1120 mm

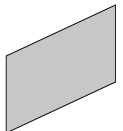
**LOG250**

Frontglas mit Logo cm 250  
B 2001 - 2500 mm / T 18 mm / H 1120 mm

**RGB250**

LED RGB für Front- und Eckmodul  
(R) 4,8W je Meter, 12 V

**LED250**

LED für Front- und Eckmodul IP20  
(C) 6000 K / 4,8W je Meter, 24 V  
(N) 4000 K / 4,8W je Meter, 24 V  
(N) 3000 K / 4,8W je Meter, 24 V

# Square

Comptoir modulaire en panneau mélaminé et stratifié avec éclairage LED.

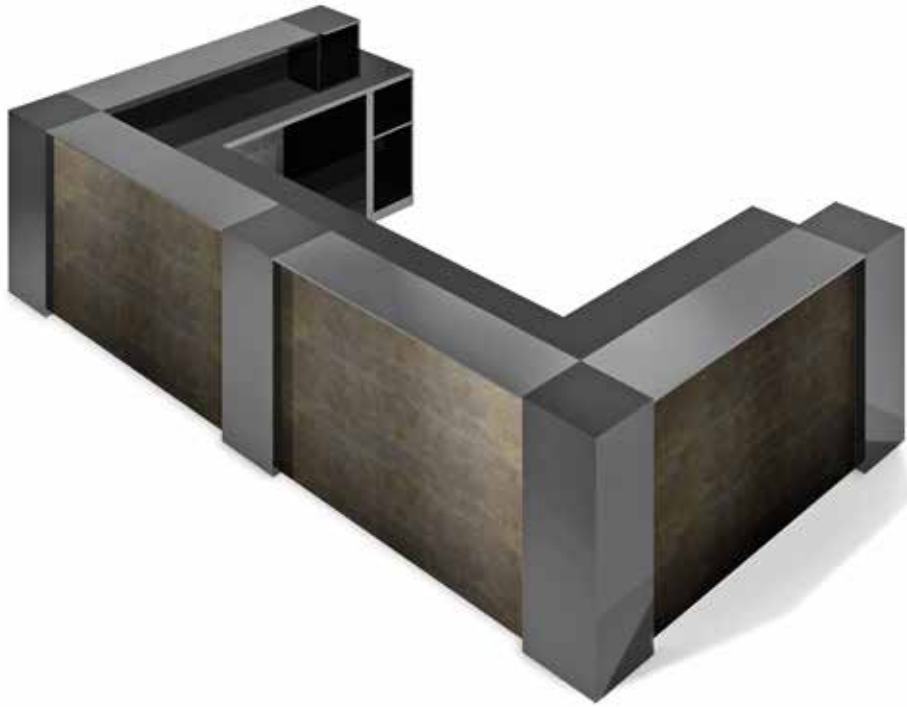

## Structure

Finitions



THE SWATCH BOOK

## Plan de travail

Finitions



Anthracite



Cachemire



Noir mat



Blanc mat

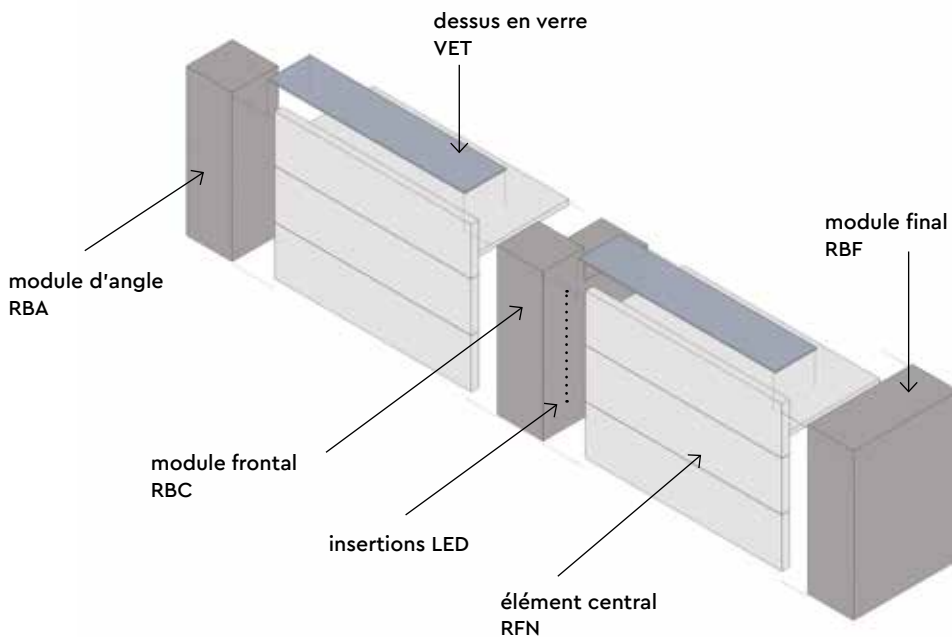

Quelques combinaisons possibles

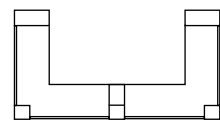

A

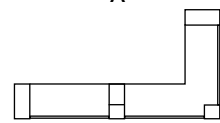

B

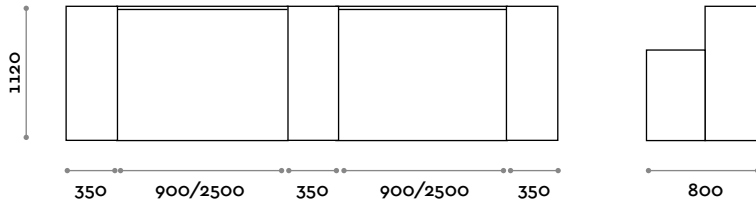

C

**RFN001**

Façade et plan en mélaminé. Hauteur du plan de travail 778 mm / 918 mm  
L 900-1300 mm / P 800 mm / H 1120 mm

**RFN002**

Façade et plan en mélaminé. Hauteur du plan de travail 778 mm / 918 mm  
L 1301-1900 mm / P 800 mm / H 1120 mm

**RFN003**

Façade et plan en mélaminé. Hauteur du plan de travail 778 mm / 918 mm  
L 1901-2500 mm / P 800 mm / H 1120 mm

**RBF001**

Meuble final en stratifié avec compartiment ouvert et deux tablettes amovibles  
L 350 mm / P 800 mm / H 1120 mm

**RBF002**

Meuble final en stratifié avec 1 tiroir et 1 porte avec tablette intérieure amovible  
L 350 mm / P 800 mm / H 1120 mm

**RBF003**

Meuble final en stratifié avec 4 tiroirs  
L 350 mm / P 800 mm / H 1120 mm

**RBC001**

Meuble central en stratifié avec compartiments ouverts et tablette mobile  
L 350 mm / P 800 mm / H 1120 mm

**RBC002**

Meuble central en stratifié avec 1 compartiment ouvert et 1 porte avec tablette interne mobile  
L 350 mm / P 800 mm / H 1120 mm

**RBC003**

Meuble central en stratifié avec 1 compartiment ouvert et 3 tiroirs  
L 350 mm / P 800 mm / H 1120 mm

**RBA001**

Meuble pour angle fermé en stratifié  
L 350 mm / P 350 mm / H 1120 mm

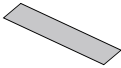
**VET001**

Plateau en verre trempé rétro-laqué  
L 900 - 1300 mm / P 350 mm / H 12 mm

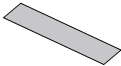
**VET002**

Plateau en verre trempé rétro-laqué  
L 1301 - 1900 mm / P 350 mm / H 12 mm

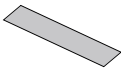
**VET003**

Plateau en verre trempé rétro-laqué  
L 1901 - 2500 mm / P 350 mm / H 12 mm

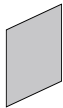
**LOG100**

Verre frontal avec logo cm 100  
L jusqu'à 1000 mm / P 18 mm / H 1120 mm

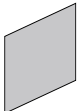
**LOG150**

Verre frontal avec logo cm 150  
L 1001 - 1500 mm / P 18 mm / H 1120 mm

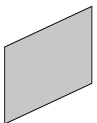
**LOG200**

Verre frontal avec logo cm 200  
L 1501 - 2000 mm / P 18 mm / H 1120 mm

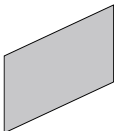
**LOG250**

Verre frontal avec logo cm 250  
L 2001 - 2500 mm / P 18 mm / H 1120 mm

**RGB250**

Led RGB pour façade et angle  
(R) 4,8W par mètre, 12 V

**LED250**

Led pour façade et angle IP20  
(C) 6000 K / 4,8W par mètre, 24 V  
(N) 4000 K / 4,8W par mètre, 24 V  
(N) 3000 K / 4,8W par mètre, 24 V

# Square

Mostrador modular de fibra de madera y laminado con luces LED.

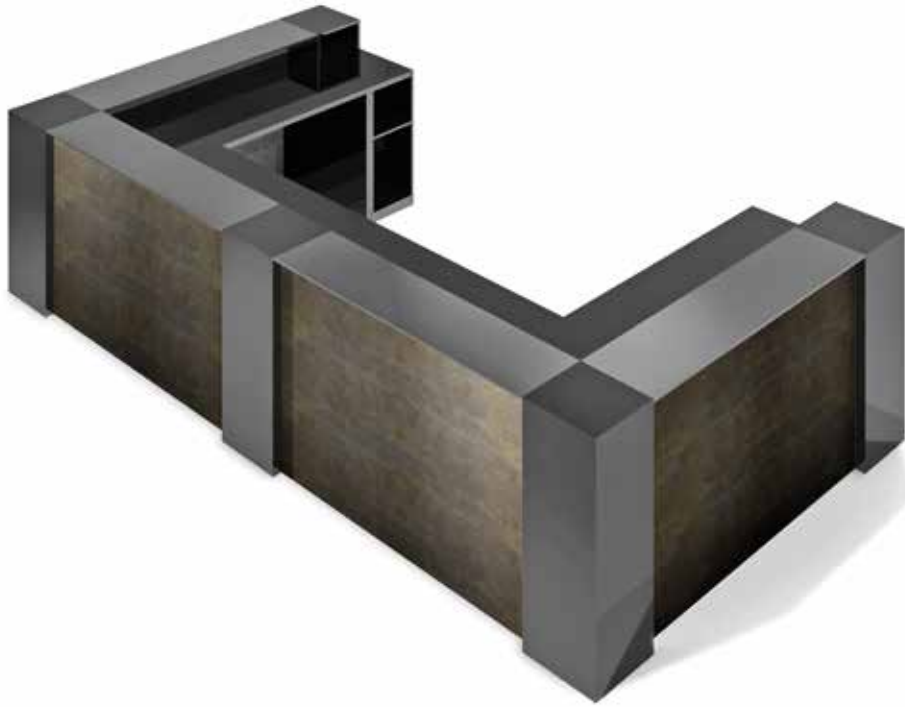

**Estructura**

Acabados



**Encimera**

Acabados

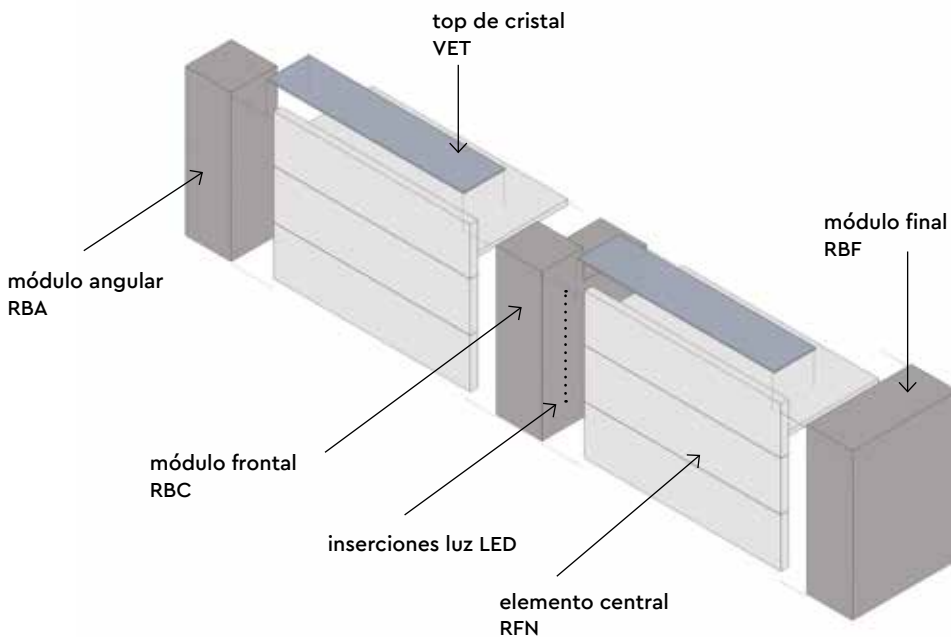

Varias posibles combinaciones

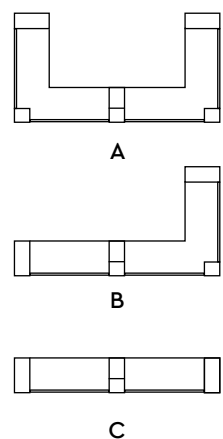

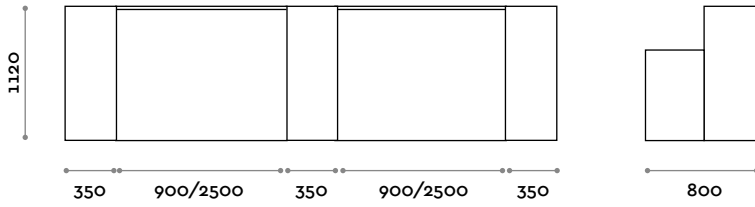
**RFN001**

Frente de ennoblecido comprendido top de ennoblecido. Altura encimera 778 mm / 918 mm  
L 900-1300 mm / P 800 mm / H 1120 mm

**RFN002**

Frente de ennoblecido comprendido top de ennoblecido. Altura encimera 778 mm / 918 mm  
L 1301-1900 mm / P 800 mm / H 1120 mm

**RFN003**

Frente de ennoblecido comprendido top de ennoblecido. Altura encimera 778 mm / 918 mm  
L 1901-2500 mm / P 800 mm / H 1120 mm

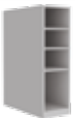
**RBF001**

Baúl final de laminado con huecos abiertos y dos repisas móviles  
L 350 mm / P 800 mm / H 1120 mm

**RBF002**

Baúl final de laminado con un cajón y una hoja con repisa interior móvil  
L 350 mm / P 800 mm / H 1120 mm

**RBF003**

Baúl final de laminado con 4 cajones  
L 350 mm / P 800 mm / H 1120 mm

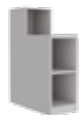
**RBC001**

Baúl central de laminado con huecos abiertos y repisa móvil  
L 350 mm / P 800 mm / H 1120 mm

**RBC002**

Baúl central de laminado con un hueco abierto y una hoja con repisa interior móvil  
L 350 mm / P 800 mm / H 1120 mm



**RBC003**

Baúl central de laminado con un hueco abierto y 3 cajones  
L 350 mm / P 800 mm / H 1120 mm

**RBA001**

Baúl para ángulo cerrado de laminado  
L 350 mm / P 350 mm / H 1120 mm

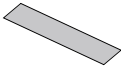
**VET001**

Top de vidrio templado lacado en la parte de atrás  
L 900 - 1300 mm / P 350 mm / H 12 mm

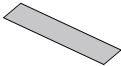
**VET002**

Top de vidrio templado lacado en la parte de atrás  
L 1301 - 1900 mm / P 350 mm / H 12 mm

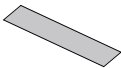
**VET003**

Top de vidrio templado lacado en la parte de atrás  
L 1901 - 2500 mm / P 350 mm / H 12 mm

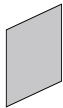
**LOG100**

Vidrio frontal con logo cm 100  
L fino a 1000 mm / P 18 mm / H 1120 mm

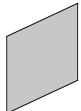
**LOG150**

Vidrio frontal con logo cm 150  
L 1001 - 1500 mm / P 18 mm / H 1120 mm

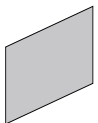
**LOG200**

Vidrio frontal con logo cm 200  
L 1501 - 2000 mm / P 18 mm / H 1120 mm

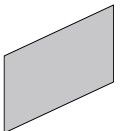
**LOG250**

Vidrio frontal con logo cm 250  
L 2001 - 2500 mm / P 18 mm / H 1120 mm

**RGB250**

LED RGB para partes frontal y angular  
(R) 4,8W por metro, 12 V

**LED250**

LED para partes frontal y angular IP20  
(C) 6000 K / 4,8W por metro, 24 V  
(N) 4000 K / 4,8W por metro, 24 V  
(N) 3000 K / 4,8W por metro, 24 V

follow us



## Fit Interiors

Gruppo P&G srl  
Via Emilia, n.3916  
47020 Longiano (FC), Italy  
tel. (+39) 0547 58746  
info@gruppopeg.com



**fit  
interiors**

furniture for health  
and golf clubs, gyms  
hotel&spa, medical  
and corporate

visit [www.fitinteriors.com](http://www.fitinteriors.com)