

fit interiors ——— designed and produced in Italy

Nordic

DESIGN FIRST.

fit interiors

Nordic

Alberto Manzoni

Modular counter with frontal solid ash slats



Structure

Finishes



Slats

Solid ash wood



Natural



Wengé

Worktop

Finishes



D143PS30
Grey



6577ST
Cashmere

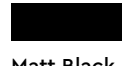

Matt Black
Wax

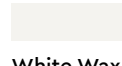

White Wax

square corner module
NOAS76 / NOAS90

End module L
NO09076S / NO09090S

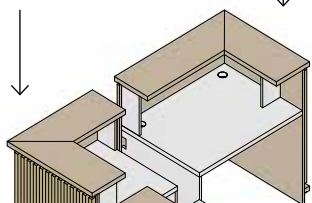

central module
NO09076C / NO09090C

central module
NO14076C / NO14090C

curved corner module
NOAC76 / NOAC90

end module R
NO14076D / NO14090D

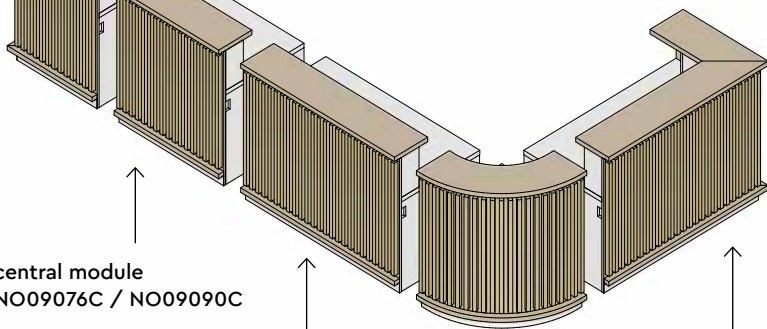

Example compositions

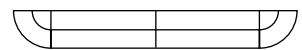

A

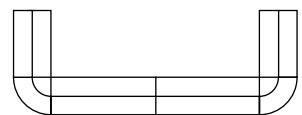

B

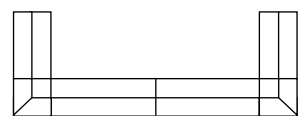

C



NO14076S

Left end module with worktop and top

- Worktop height 778 mm
- MFC structure
- Top, worktop and lower band 36 mm thickness
- Solid ash slats
- 4000 k° natural white LED light
- Worktop with 2 metal cable glands

Dimensions

W 1445 mm / D 773 mm / H 1127 mm



NO14090S

Left end module with worktop and top

- Worktop height 918 mm
- MFC structure
- Top, worktop and lower band 36 mm thickness
- Solid ash slats
- 4000 k° natural white LED light
- Worktop with 2 metal cable glands

Dimensions

W 1445 mm / D 773 mm / H 1127 mm



NO14076D

Right end module with worktop and top

- Worktop height 778 mm
- MFC structure
- Top, worktop and lower band 36 mm thickness
- Solid ash slats
- 4000 k° natural white LED light
- Worktop with 2 metal cable glands

Dimensions

W 1445 mm / D 773 mm / H 1127 mm



NO14090D

Right end module with worktop and top

- Worktop height 918 mm
- MFC structure
- Top, worktop and lower band 36 mm thickness
- Solid ash slats
- 4000 k° natural white LED light
- Worktop with 2 metal cable glands

Dimensions

W 1445 mm / D 773 mm / H 1127 mm



NO14076C

Central module with worktop and top

- Worktop height 778 mm
- MFC structure
- Top, worktop and lower band 36 mm thickness
- Solid ash slats
- 4000 k° natural white LED light
- Worktop with 2 metal cable glands

Dimensions

W 1400 mm / D 773 mm / H 1127 mm



NO14090C

Central module with worktop and top

- Worktop height 918 mm
- MFC structure
- Top, worktop and lower band 36 mm thickness
- Solid ash slats
- 4000 k° natural white LED light
- Worktop with 2 metal cable glands

Dimensions

W 1400 mm / D 773 mm / H 1127 mm



NO09076C

Central module with worktop and top

- Worktop height 778 mm
- MFC structure
- Top, worktop and lower band 36 mm thickness
- Solid ash slats
- 4000 k° natural white LED light
- Worktop with 2 metal cable glands

Dimensions

W 952 mm / D 773 mm / H 1127 mm



NO09090C

Central module with worktop and top

- Worktop height 918 mm
- MFC structure
- Top, worktop and lower band 36 mm thickness
- Solid ash slats
- 4000 k° natural white LED light
- Worktop with 2 metal cable glands

Dimensions

W 952 mm / D 773 mm / H 1127 mm



NO09076S

Left end module with worktop and top

- Worktop height 778 mm
- MFC structure
- Top, worktop and lower band 36 mm thickness
- Solid ash slats
- 4000 k° natural white LED light
- Worktop with 2 metal cable glands

Dimensions

W 997 mm / D 773 mm / H 1127 mm



NO09090S

Left end module with worktop and top

- Worktop height 918 mm
- MFC structure
- Top, worktop and lower band 36 mm thickness
- Solid ash slats
- 4000 k° natural white LED light
- Worktop with 2 metal cable glands

Dimensions

W 997 mm / D 773 mm / H 1127 mm



NO09076D

Right end module with worktop and top

- Worktop height 778 mm
- MFC structure
- Top, worktop and lower band 36 mm thickness
- Solid ash slats
- 4000 k° natural white LED light
- Worktop with 2 metal cable glands

Dimensions

W 997 mm / D 773 mm / H 1127 mm



NO09090D

Right end module with worktop and top

- Worktop height 918 mm
- MFC structure
- Top, worktop and lower band 36 mm thickness
- Solid ash slats
- 4000 k° natural white LED light
- Worktop with 2 metal cable glands

Dimensions

W 997 mm / D 773 mm / H 1127 mm

**NOAS76****Square corner module with worktop and top**

- Worktop height 778 mm
- MFC structure
- Top, worktop and lower band 36 mm thickness
- Solid ash slats
- 4000 k° natural white LED light

Dimensions

W 773 mm / D 773 mm / H 1127 mm

**NOAS90****Square corner module with worktop and top**

- Worktop height 918 mm
- MFC structure
- Top, worktop and lower band 36 mm thickness
- Solid ash slats
- 4000 k° natural white LED light

Dimensions

W 773 mm / D 773 mm / H 1127 mm

**NOAC76****Rounded corner module with worktop and top**

- Worktop height 778 mm
- MFC structure
- Top, worktop and lower band 36 mm thickness
- Solid ash slats
- 4000 k° natural white LED light

Dimensions

W 773 mm / D 773 mm / H 1127 mm

**NOAC90****Rounded corner module with worktop and top**

- Worktop height 918 mm
- MFC structure
- Top, worktop and lower band 36 mm thickness
- Solid ash slats
- 4000 k° natural white LED light

Dimensions

W 773 mm / D 773 mm / H 1127 mm



Finishes

Wood



K4410AW
NATIVE OAK LIGHT



S073
ST JAMES PARK SHERWOOD



LK48
NOCE LEUCA MATRIX



K5413RO
QUERCIA ENDGRAIN COGNAC



A892
MURANO



4043
NOCE ADIGE

Concrete



44374DP
CEMENTO GRIGIO OPALE



44407DP
CEMENTO PLATINO



44405DP
CEMENTO GRIGIO ARDESIA



Black and White



MILLENNIUM WHITE



MILLENNIUM BLACK

Fabric



**FA44
KAKI PENELOPE**



**FA46
GUERRILLA PENELOPE**



**FA33
MAYA BRONZE PENELOPE**

Metal



**44408DP
RUGGINO RAME BRONZO**



**0794
PATINA BRONZE**



**U005
URBAN IRON**



Stone



K5580DP
CHEPE



K4892
PIETRA GREY

Solid Color

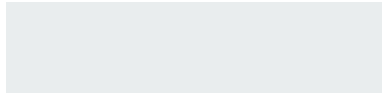

WHITE WAX

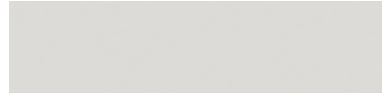

6577ST
CASHMERE



2134PE
ZINC YELLOW



25717NM
EARTH



U321
CHINA RED



26299BS
COBALT GREY



D143PS30
GREY



20244NM
PETROLEUM



25718NM
BLUE MOROCCO

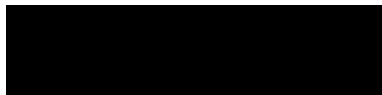

MATT BLACK WAX

follow us



**fit
interiors**

**furniture for gyms,
health and golf clubs,
spa&wellness, hotel,
medical and corporate**

visit www.fitinteriors.com